



Fall Protection

Full Line Catalog

3M™ DBI-SALA® Fall Protection



United States

Enjoy the view. We've got your back.

Safety managers. Workers.
Business owners. Everyone at a
worksite plays a role in helping
keep people healthy and safe.
At 3M, our role is supporting
you with the right resources
to get the job done and bring
your workers back home
through the science of safety.

#3MScienceOfSafety



10 feet in the air or 100, you need the confidence to know you're safe at height no matter where the job takes you. That's why our dedicated team of Fall Protection specialists meets with customers out in the field. We work to understand the unique challenges you face and develop the products, systems and services that help keep you safe and compliant with fall protection standards in a variety of industries.

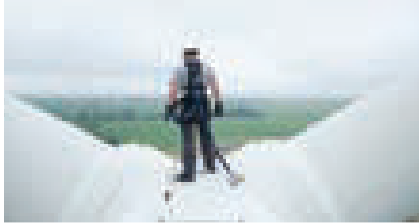

Wind energy

Specialized equipment for a specialized industry—harnesses, lanyards and unique rescue and escape systems.

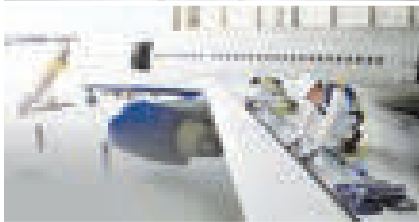

Transportation

From the airport to the railyard, there's a 3M Fall Protection solution for all aspects of this diverse industry.



Oil and gas

With "retractable" lifeline technology and equipment and training for emergency escape devices, 3M Fall Protection helps keep this vital industry running.



Mining

Rugged work requires rugged equipment. That's why we developed specialized harnesses and anchors to address the demands of the mining industry.



Construction

We've built a portfolio of 3M Fall Protection for the specific needs of the construction industry—to help keep you building.



General industry

Whether you're processing, milling, finishing, inspecting or doing routine maintenance, 3M Fall Protection can help you get the job done safely.

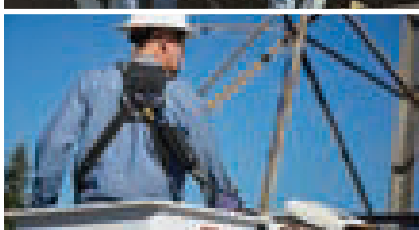

Utility, telecom and municipalities

With products like our confined space equipment and pole anchors, we specialize in fall protection equipment as unique as the work you do.



Table of contents

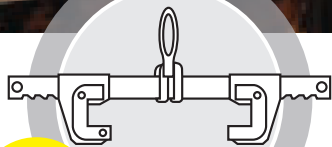

A

Anchorage

are a secure point of attachment. Anchorage connectors vary by industry, job, type of installation and structure. They must be able to support the intended loads and provide a sufficient factor of safety for fall arrest.

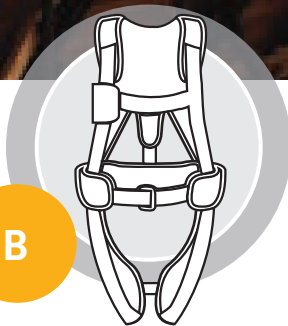

B

Body support

harnesses distribute fall forces over the upper thighs, pelvis, chest and shoulders. They provide a connection point on the worker for the personal fall arrest system.



C

Connectors

such as self-retracting lifelines or shock-absorbing lanyards connect a worker's harness to the anchorage.

Anchorage connectors	7
Horizontal systems.....	17
Vertical systems	25
Engineered systems	35
Flexiguard™ solutions	37

Full-body harnesses	45
Lineman belts and harnesses	62
Belts, workseats and accessories	63

Self-retracting lifelines.....	65
Shock-absorbing lanyards.....	75
Positioning lanyards.....	81
Fall-restricting devices.....	82



The ABC's of fall protection.

A typical Personal Fall Arrest System (PFAS) incorporates three components, often described as the ABC's of fall protection. The anchorage/ anchorage connector, body support and connecting device—when used together—form a complete system for maximum worker protection. But don't forget the other important components of a comprehensive fall protection program: descent and rescue, education and fall protection for tools.



D

Descent and rescue

devices are used to raise or lower a fallen injured worker to safety or retrieve him from a confined space.



E

Education

is essential. We offer a variety of training and consultative services to fit your needs.

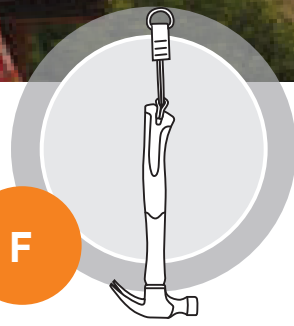

F

Fall protection for tools

helps make work environments safer and more productive by reducing dropped object incidents.

Confined space rescue85
 Rescue and descent 102
 Netting & guardrails.....110

Training courses119

Fall protection for tools 121

NEW

Products on next page

New products

Elevate safety and comfort.

Harnesses

3M™ DBI-SALA® Delta™ Comfort Arc Flash Harness **1112613**

Experience quick, easy donning made possible by a patented Delta™ triangular design. Arc flash-rated and resistant up to 40 cal/cm² for high voltage electricity applications (XLarge).

1112610 Small

1112611 Medium

1112612 Large



3M™ DBI-SALA® Delta™ Comfort Scaffolding Harness **1100948**

These harnesses feature a fixed back D-ring and a web Easy-Link Self-Retracting Lifeline Adapter, allowing you to easily attach your personal SRL. Also available in quick-connect configurations (XLarge).

1100945 Small

1100946 Medium

1100947 Large

1109454 Universal



Fall Protection for Tools

3M™ DBI-SALA® 5 lb. Retractable Tool Lanyard **1500156**

Help minimize tangling and tripping hazards with this compact and lightweight tool retractor designed to secure tools up to 5 lbs.



3M™ DBI-SALA® Harness Adapter - **1500161**



3M™ DBI-SALA® Quick-Wrap Tape II

Create secure tool attachment points using up to 40% less tape*.

Yellow (1 in. x 9 ft.) - **1500174**

Blue (1 in. x 9 ft.) - **1500168**

Blue Double Roll (1 in. x 18 ft.) - **1500171**

*Compared to previous generation 3M™ DBI-SALA® Quick-Wrap Tape.

3M™ DBI-SALA® Hook2Hook Coil Tether **1500159**

A simple tethering solution for tools weighing up to 5 lbs. that stays out of the way when not in use.



Hard Hat Tether

1500178, 1500179

Qty. 10 or 100.
Load Rating: 4 lbs. (1.8 kg)

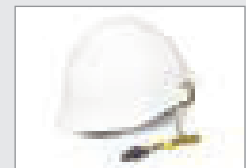

3M™ DBI-SALA® Large Tape Measure Sleeve **1500165**

Keep your tape measure secured and ready to work. The Tape Measure Sleeve creates a secure attachment point on most tape measures up to 35 ft.



Self-Retracting Lifelines

3M™ DBI-SALA® Nano-Lok™ Self-Retracting Lifeline for Aerial Work Platforms - **3101655**

Helps enhance your mobility in bucket trucks and aerial work platform applications. Flame-resistant with a retractable design, it keeps the lifeline out of the way and helps reduce dragging, snagging and trip hazards for high voltage electricity applications x 4.5 ft.



3M™ DBI-SALA® Nano-Lok™ Wrap Back Self-Retracting Lifelines - **3101659**

A versatile, easy-to-use SRL specifically designed for tie-back use often found in construction applications. Can be used for direct connection to most harnesses x 8 ft.



3M™ DBI-SALA® Comfort Grip Connector

Can be used for direct connection to anchorage structures like scaffolding and towers, the Comfort Grip Connector snap hook is offered on a variety of lanyards and personal self-retracting lifelines, including:

3M™ DBI-SALA® Shockwave™2 Shock-Absorbing Lanyard - **1246416**

3M™ DBI-SALA® Nano-Lok™ edge Self-Retracting Lifeline x 8 ft. - **3500258**



1246416



3500258

Coming Soon

3M™ DBI-SALA® ExoFit™ Plus and ExoFit NEX™ Plus Full-Body Harnesses

In addition to the features you already get with the ExoFit or the ExoFit NEX, they now will both also provide the flexibility of an integrated easy-link self-retracting lifeline adapter.

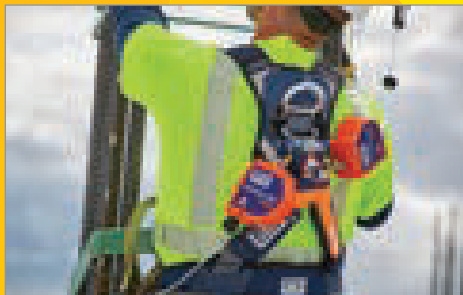

3M.com/NEXPlus

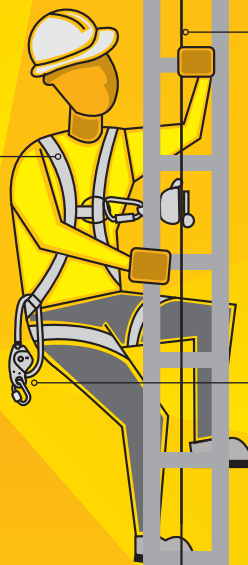

3M™ DBI-SALA® Lad-Saf™ Flexible Cable Vertical Safety System

Reengineered to help streamline your installation time with over 70% fewer loose components compared to current generation, these lightweight systems are optimized for easy, effective installation and maintenance.

3M™ DBI-SALA® Trigger X Adjustable Rope Positioning Lanyard

Get the versatility you need with this lanyard. It has three work modes and is available in three hook configurations and three lengths (6 ft., 8 ft. and 10 ft.).

New ANSI Z359.16 Standard

Whether you manufacture, distribute, purchase, design, install or use these systems, this new standard probably affects you. Here are some key changes that you need to be aware of. See our Technical Bulletin or contact customer service for more information.

This standard applies to any vertical climbing system that's 90° (plus or minus 1°) when viewed from the front elevation and within 15° of vertical from the side elevation.

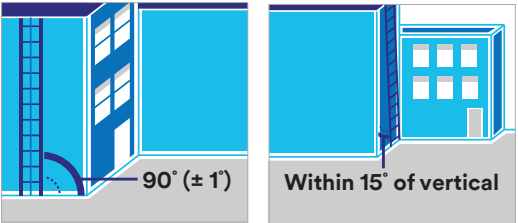

KEY CHANGE:

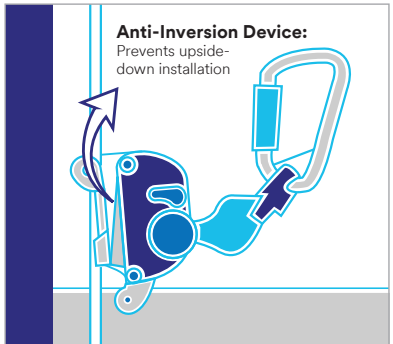

Carrier sleeves must now include an anti-inversion device to prevent the user from installing the carrier sleeve upside-down.

KEY CHANGE:

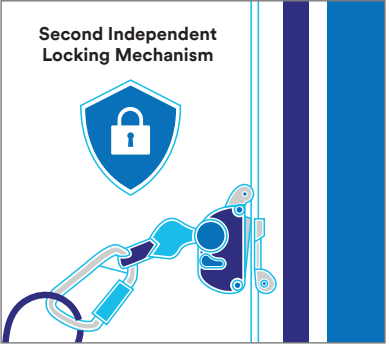

Sleeves must lock automatically in a fall and must include a second independent locking mechanism that can't be disengaged or interfered with during a fall.

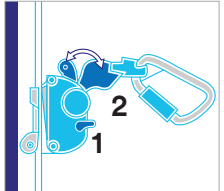

Sleeves designed to be removable from the carrier cable must require at least 2 deliberate manual actions by the user.

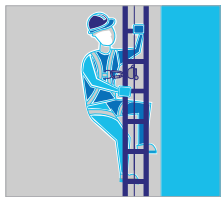

During climbing and descent, sleeve movement should be automatic, not requiring manual intervention.

Anchorage Connectors



The more you trust an anchor, the more you enjoy the view.

Set your sights on a higher level of confidence and security with 3M™ DBI-SALA® Anchorage Connectors. Tested to meet OSHA and ANSI standards, our comprehensive portfolio of anchorage connectors gives you the gear you need to get the job done right.

- Anchorages for general/all-purpose, steel, concrete, roof, mining or specialty.
- Fixed or mobile.
- Permanent or portable.

All anchorages must provide a secure point of attachment for a complete personal fall arrest system and must be capable of supporting a load of 5,000 lbs. (22 kN), or of meeting OSHA's criteria of a 2-to-1 safety factor.

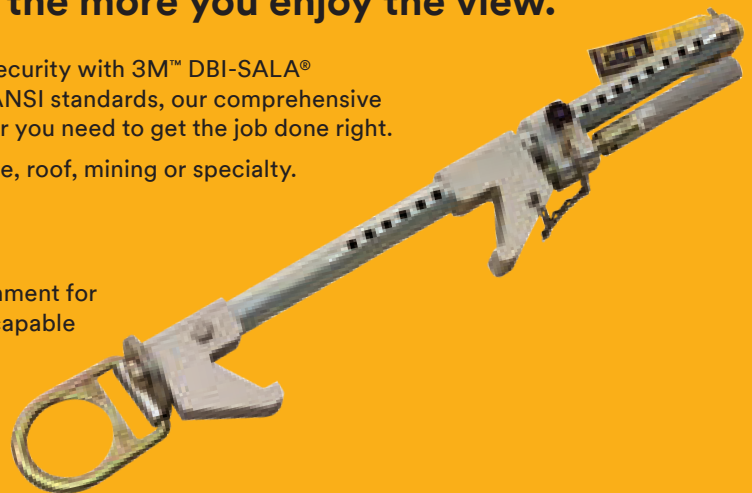

3M™ DBI-SALA® General Anchorage Connectors

Extremely versatile anchors are easily choked-off to the anchorage structure, to provide a fast and safe 5,000 lb. (22 kN) tie-off point for your personal fall protection system.

1003000

Web Tie-Off Adapter

Pass-through design. 1-3/4 in. polyester strength member with 3 in. wide polyester wear pad x 3 ft. (0.9 m)

1003006 Web Tie-Off Adapter, pass-through type x 6 ft. (1.8 m)

1002103 Adjustable Web Tie-Off Adapter, pass-through type x 3 ft. (0.9 m)

1002106 Adjustable Web Tie-Off Adapter, pass-through type x 6 ft. (1.8 m)

1002010 Web Tie-Off Adapter, pass-through type x 10 ft. (3.0 m)



1201390

Web Scaffold Choker

Choker style attaches to 3 in. (76 mm) diameter anchorage. 1 in. (25 mm) polyester strength member x 17 in. (43 cm)

1201391 Web Scaffold Choker x 24 in. (61 cm)

1201422 Coated Web Scaffold Choker, PVC Coated D-ring x 2 ft. (0.6 m)

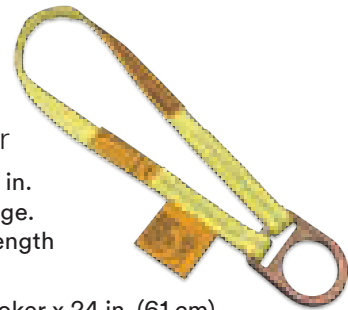

1002202

Tie-Off Adapter for Hot Work Use

Reinforced with Kevlar® fiber webbing; ideal for high heat environments, pass-through type with 1-3/4 in. polyester strength member x 6 ft. (1.8 m)

1002200 Tie-Off Adapter, with Kevlar® fiber, pass-through type x 3 ft. (0.9 m)

1002201 Tie-Off Adapter, with Kevlar® fiber, pass-through type x 4 ft. (1.2 m)



3M™ DBI-SALA® Safflok™ Steel Carabiners



2000112

11/16 in. (17.5 mm) gate opening steel carabiner with self closing/locking gate. 3,600 lb. (16 kN) gate strength.



2000113

1-3/16 in. (30 mm) gate opening steel carabiner with self closing/locking gate. 3,600 lb. (16 kN) gate strength.



2000114

2-3/16 in. (55.5 mm) gate opening steel carabiner with self closing/locking gate. 3,600 lb. (16 kN) gate strength.

5900550

Cable Tie-Off Adapter

Pass-through design. 7 in. x 19-3/8 in. (9.5 mm) stainless steel cable with O-rings x 4 ft. (1.2 m)

5900551 Cable Tie-Off Adapter, pass-through type x 6 ft. (1.8 m)

5900552 Cable Tie-Off Adapter, pass-through type x 10 ft. (3.0 m)



2104816

Drop-Through Anchor

10 ft. (3 m) drop-through anchor with swiveling D-ring for concrete and steel, fits 1-1/2 in. to 1-3/4 in. dia. hole (38.1 to 44.5 mm) with a minimum thickness of 4 in. (101.6 mm)

2104819 Drop-Through Anchor x 2 ft. (0.6 m)

2104818 Drop-Through Anchor x 6 ft. (1.8 m)

2104817 Drop-Through Anchor x 8.5 ft. (2.6 m)



3M™ DBI-SALA® Steel Anchorage Connectors

Extremely versatile anchors for steel that are lightweight and compact, providing an easy to install and safe 5,000 lb. (22 kN) tie-off point for your personal fall protection system.

2104700 Sliding Beam Anchor



- Provides horizontal mobility on I-beams, overhead attachments or at the feet.
- Wear pads provide smooth operation.
- Ratcheting adjustment system for easy installation.
- User capacity of 420 lbs. (189 kg)

2110941 Sliding Beam Anchor



Features a detent-pin type adjustment system. Fits flanges between 6 in.-18 in. wide and up to 2-1/2 in. thick.

2108406 Fixed Beam Anchor



It installs in seconds to the beam structure in any orientation, with final tightening using a built-in adjustment handle. Ideal as a single-person anchor point or as end-anchors for a 3M™ DBI-SALA® Sayflin™ Horizontal Lifeline System. Fits up to 1-1/2 in. thick beam flange, 2-1/2 in.-12 in. wide.

2108407 Fixed Beam Anchor, fits up to 1-1/2 in. thick x 2-1/2 in.-18 in. wide beam flange.

2108408 Fixed Beam Anchor, fits up to 1-1/2 in. thick x 2-1/2 in.-24 in. wide beam flange.

2108410 Fixed Beam Anchor, fits up to 1/2 in.-2-1/2 in. thick x 12 in.-36 in. wide beam flange.

2103143 Trolley for I-Beam

The trolley is for use with self-retracting lifelines on horizontal beams and has been engineered for ease-of-use and superior performance. It glides easily along the beam and provides horizontal mobility.

- Attachable anywhere along beam, including midpoint.
- Non-corrosive double-shielded wheel bearings are maintenance-free.
- Trolley guards protect the wheels from damage and keep beam clear of debris.
- Fits 3 in.-8 in. flange width and thickness up to 11/16 in.

2103147 Trolley for I-Beam, all stainless steel, fits 3 in.-8 in. flange width and thickness up to 11/16 in.



8800023 Tandem Pulley

For 3/8 in.-1/2 in. rope or cable.



2104550 Steel Plate Anchor

This plate anchor offers a compact, reliable attachment to 3/8 in.-1 in. thick plate steel for connecting your lanyard, vertical lifeline system or self-retracting lifeline.

- Easy-to-use set-screw design ensures positive and safe connection.
- Complete with integral D-ring tie-off point.
- Durable, corrosion-resistant zinc-plated steel construction.



3M™ DBI-SALA® Steel Anchorage Connectors (cont.)

2101630

D-Ring Anchorage Plate

The D-Ring Anchorage Plate can be bolted or welded to a structure, offering a compact, reliable connection point for your fall protection system.

- Two 1/2 in. diameter attachment holes.
- Cadmium-plated steel D-ring.
- 304 stainless steel anchorage plate.
- Plate size: 1/4 in. x 2 in. x 4-1/2 in.

2101634 D-Ring Anchorage Plate with cadmium-plated steel D-ring, raw steel anchorage plate.

2101636 D-Ring Anchorage Plate with 304 stainless steel D-ring and anchorage plate.

2101638 D-Ring Anchorage Plate with 316 stainless steel D-ring and anchorage plate.



3M™ DBI-SALA® Concrete Anchorage Connectors

Extremely versatile anchors for concrete that are lightweight and compact, providing an easy to install and safe 5,000 lb. (22 kN) tie-off point for your personal fall protection system.

2100085

Concrete Wedge Anchor

Portable and reusable concrete anchor installs quickly and easily using standard concrete tools, providing a fast and safe tie-off point.

- Exclusive quick-release button for fast removal.
- Unique forged connection ring provides a compatible tie-off point.
- Shielded load cable and chock release cables.
- Exclusive pivoting easy-grip handle.



2100050

Concrete Anchor Strap

Our disposable concrete anchor strap provides a temporary anchorage on concrete forms and is extremely easy to install and use.

- Loop slips over rebar, then concrete is poured over. When no longer needed, simply cut strap and discard.
- Durable 1-3/4 in. polyester construction x 3-1/2 ft. (1 m). Full length wear pad for abrasion resistance.
- D-ring provides compatible tie-off point.



2100053 Concrete Anchor Strap with D-ring, 48 in. (1.2 m)

2100061 Concrete Anchor Strap, no D-ring, 3-1/2 ft. (1 m)

2100101

Toggle Anchor

Portable and reusable anchor installs in just seconds to concrete or steel for horizontal, vertical, or overhead applications, providing a compatible, fast and safe tie-off point.

- Activator cable provides toggle mode selection (Open or Lock).
- Toggle position indicator visually notifies user if locked or unlocked.
- Swiveling D-ring provides a compatible tie-off point.



2104560

Concrete D-Ring Anchor

A simple, versatile and safe concrete anchor solution for use in temporary or permanent applications, providing a safe tie-off point.

- Reusable D-ring assembly.
- Rugged design for harsh environments.
- Safe “hook-up” indicator notifies user of proper installation.
- Install into 11/16 in., 18 mm or 3/4 in. holes—only standard drill bits needed.



2104561 Concrete D-Ring Anchor with 5 additional bolts.

2104562 Concrete D-Ring Anchor with 11 additional bolts.

2100066 10-pack of Replacement Bolts for Concrete D-Ring Anchor.

2101004

Concrete Detent Anchor

A versatile, simple and safe concrete anchor utilizing pre-installed sockets, enabling the user to connect and disconnect from the anchorage by simply pressing a button.

- Use for floor, wall or ceiling type applications.
- Provides convenient tie-off points wherever needed.
- Push-button operation for fast and easy operation.
- Socket includes cover cap to hide recess, blending into the decor.



2101000 Concrete Detent Socket and cap only.

2101002 Concrete Detent Pin only.

2100152 Concrete Pour-in-Place Anchor.

2100169 Pour-in-Place Detent Anchor Assembly with detent pin and socket.

8523178

Concrete Parapet Anchor

Portable anchorage connector developed for use in locations where a low parapet wall provides an anchor site for a shock-absorbing lanyard or self-retracting lifeline.

- Non-penetrating design eliminates site damage.
- Adjustment range 1 in.-14.5 in. wide.
- No tools required for installation.

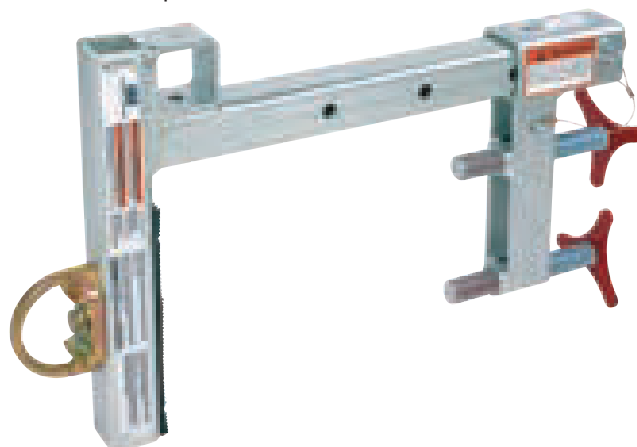

1231305

Web Anchor

Anchor can be directly connected to many concrete wall forms to provide a tie-off point for your system. Web anchor strap with large opening, Hook at one end, D-ring at other x 1.5 ft. (45 cm)



3M™ DBI-SALA® Roof Anchorage Connectors

Wood or steel. Residential or commercial. Flat or sloped. No matter what type of roof you're working on, your fall protection system needs specialized components to help keep you safe. Our easy-to-use kits and anchorage devices provide reliable solutions and meet the latest OSHA and ANSI standards.



2100133
Roof Top Anchor for metal, concrete, wood roofs



2100138
Standing Seam Roof Anchor



2100139
Roof Top Anchor for membrane type roofs



2100185
Freestanding Counterweight Anchor

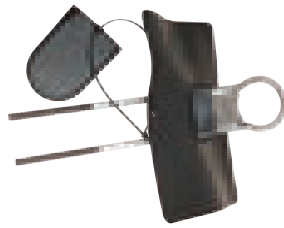

2103670
Permanent Roof Anchor with flashing and cap



2103673
Portable Reusable Roof Anchor



2103675
Portable/Reusable Standing Seam Roof Anchor



2103677
Portable Reusable Roof Anchor



2104541
Detachable Roof Anchor with flashing



2103677
Portable Reusable Roof Anchor



2103690
3-Man Reusable Swiveling Roof Anchor

Selection Guide:

Part #	Wood attachment - OK	Metal attachment -OK, minimum thickness	OK to Use with HLL	Capacity - Maximum Arresting Force	Attachment method	Permanent installation	OSHA Compliant	ANSI Z359 compliant
2100133	■ (5/8 in. plywood)	■ 24 Ga.	■	310 lbs./1800 MAF	Lag screws (wood), anchors (concrete), rivets or Fablok or Tek screws (metal)	■ (5/8 in. plywood)	■	■
2100138		■ Fits standing seam centers 15.75 in. x 11.8 in. w/clamp kits	■	310 lbs./1800 MAF	7241204 for bulb type seam, 7241206 for double folded standing seam, 7241208 for single folding seam	■		
2100139		■ Installs to standard membrane and built-up type roofs	■	310 lbs./1800 MAF	4 bolts: 7241182 6 in. toggle bolt, or 7241183 12 in. toggle bolt	■	■	■
2100140		■ Single-ply PVC membrane and built-up roofs	■	310 lbs./1800 MAF	7241182 or 7241183 toggle bolt	■		
2100142		■ Single ply Bitumin and built-up roofs	■	310 lbs./1800 MAF	7241182 or 7241183 toggle bolt	■		
2100185		■ Flat roofs up to 5 degrees of slope		310 lbs./1800 MAF	7241182 or 7241183 toggle bolt			
2103670	■			310 lbs./1800 MAF	U -Bolt clamps (included) to rafter or truss, 2 x 4 , 2 x 8	■	■	■
2103671	■			310 lbs./1800 MAF	U -Bolt clamps (included) to rafter or truss, 2 x 10, 2 x 12	■	■	■
2103673	■		■ Synthetic Sayflin™ or PRO-Line of slope	310 lbs./1800 MAF (2 person w/ Sayflin™ Synthetic HLL)	6 (1/4 inch size) Lag screws (included) or 12 nails (included)		■	■
2103675		■ Flat roofs up to 5 degree of slope		310 lbs./900 MAF	Clamps to seam		■	
2103676	■	■ 22 Ga. deck		310 lbs./1800 MAF	Nails or Tek screws		■	
2103677	■			420 lbs./900 MAF	Lag screws		■	
2103690	■			3 Person, 310 lbs. ea. /1350 MAF	Deck screws		■	
2104540	■			310 lbs./1800 MAF	Bolts w/clamp	■	■	■
2104541	■			310 lbs./1800 MAF	Bolts w/clamp	■	■	■
2104542	■			310 lbs./1800 MAF	Bolts w/clamp	■	■	■
2105682	■			310 lbs./900 MAF	Lag screws or nails		■	
2105683	■	■ 16 Ga. purlins or 22 Ga. decking	■ Synthetic Sayflin 7600502-7600510	310 lbs./1800 MAF (900 MAF w/HLL)	Lag screws or self-drilling screws		■	■

Read user instruction manual for complete information on use and limitations.



2104168

Roofers Fall Protection Kit

Complete fall protection system in a bag for convenient compliance and safety on the job.

Kit includes:

- Reusable Roof Anchor (2103673)
- Full-Body Harness (1103513)
- Rope Adjuster with Shock-Absorbing Lanyard (1246037)
- Lifeline x 50 ft. (1202794)
- Counterweight (5901583)
- Carrying Bag (9503806)

2104169 Roofers Fall Protection Kit with Roof Anchor (2103676)

3M™ DBI-SALA® Remote Anchoring Systems



2104527

Remote Anchoring System

Provides a safe means to anchor a fall protection device to an overhead location beyond normal reach.

- Pole adjusts from 6 ft.-12 ft. (1.8 m-3.6 m)
- Tie-off adapter tool for installation of anchorage device.
- Hook attachment tool for installation of 3,600 lb. gated snap hooks.
- Tie-off adapter x 3 ft. (0.9 m) and carrying bag.

2104528 System with 8 ft.-16 ft. (2.4 m-4.8 m) adjustable pole

2104529 Snap Hook Connector Tool for 3,600 lb. gated hooks.

2104530 System, 6 ft.-12 ft. (1.8 m-3.6 m) adjustable pole with original and 3,600 lb. gated hook tools.

2104531 System, 8 ft.-16 ft. (2.4 m-4.8 m) adjustable pole with original and 3,600 lb. gated hook tools.



2100090

Perimeter Limiter Leading Edge Anchor

Freestanding, non-penetrating anchor for concrete decking construction and provides overhead anchorages for up to two users.

- Large foam filled trailer tires won't go flat and provide easy movement.
- Rotating 7.5 ft (2.3 m) mast and anchorage arm for added freedom of movement.
- Pre-drilled holes for accessory rescue winches or job site boxes.
- Additional weights and taller mast (available separately) can be added for job site flexibility.

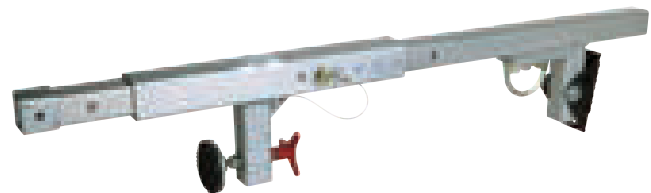

2100080

Door/Window Jamb Anchor

Non-penetrating anchor is lightweight and portable, requiring no tools for attachment. Adjustable opening ranging from 21.5 in.-51.5 in. (54.6 cm-130.8 cm). Rated for 3,600 lb. (16 kN)

3M™ DBI-SALA® Self-Contained Vacuum Anchor System

This Self-Contained Vacuum Anchor (SCVA) System allows workers to conveniently anchor to virtually any compatible, smooth, non-porous surface—enabling them to work where they need to without compromising their fall protection safety. At just over 19 lbs., it's easy to transport and use. It connects in seconds and gives workers the freedom to move about with confidence. All models are OSHA, CE and AS/NZS compliant and feature a comprehensive backup system to enhance worker safety.



For aviation maintenance applications, use 3M™ DBI-SALA® Nano-Lok™ Wrap Back Self-Retracting Lifelines *Page 5*



Product specifications:

	Shop air powered	Shop air/gas powered
Main support assembly	Anodized aluminum	
Vacuum seal pad material – aviation	EPDM	
Vacuum seal pad material – general industry	Polybutadiene	
Electronics	4 AA lithium batteries	
Shop air requirements	80 psi-150 psi	
Compressed gas bottle requirements	—	3,000 psi, 48 in ³
Dimensions	22 in. x 22 in. x 6 in. (55 cm x 55 cm x 15 cm)	
System weight	17.4 lbs. (7.8 kg)	19.9 lbs. (9.0 kg)
Capacity	310 lbs. (140 kg); One person	
Surface temperature range	-20°F to 140°F (-29°C to 60°C)	
Vacuum anchor static capacity	3,375 lbs. (15 kN)	

Selection guide:

Components	Aviation	General industry
SCVA assembly (shop air powered)	2200107*	2200094*
SCVA assembly with on board bottle attachment (shop air or gas powered)	2200108*	2200095*
Secondary pad assembly (optional)	2200109*	2200096*
Secondary pad hose (optional) – 50 ft. (15 m)	2200130	
Aviation HLL kit (includes secondary pad, 40 ft. HLL, and secondary pad 50 ft. hose)	2200123	—
Compressed gas cylinder (bottle sold separately)	2200078	

*Recommended lanyard is 1246170. Carry case included.

Lifelines that work for your work site.

Maximize mobility, productivity and fall protection with 3M™ DBI-SALA® Horizontal Lifeline (HLL) Systems. With a wide variety of HLLs available, we have the systems that are right for your site.



3M™ DBI-SALA® Horizontal Systems

Choosing a horizontal lifeline system

It's critical to choose a system that has been precision engineered and rigorously tested to meet OSHA requirements. Some other important considerations include:

Anchorage structure

The I-beam, rebar stud, concrete column or roof you attach your system to can dictate the type of system required.

Portable or permanent

Temporary jobs require portable systems that can be moved efficiently from one location to another. For hazardous areas that need to be accessed often, a permanent solution may be a better choice.

Lifeline type

Synthetic lines are lightweight and compact, while galvanized or stainless steel offer enhanced corrosion and abrasion resistance.

Number of users

Consider the number of workers required and choose a system that can accommodate them safely.

Clearance requirements

The distance between the work area and the next level or obstruction below is called "fall clearance." Anchorage height, type of lifeline and length are some of the factors that will affect the required clearance needed.



3M™ DBI-SALA® SecuraSpan™ Horizontal Lifeline (HLL) Systems

These systems incorporate a modular, multi-base design that accommodates a wide range of steel and concrete beams.

- Interchangeable stanchions—great for steel and concrete applications.
- Lightweight and portable.
- Fast and easy setup and use.
- Single and multi-span options available.
- Pass-through bracket provides 100% tie-off capability.
- Integrated 3M™ DBI-SALA® Zorbit™ Energy Absorber limits forces on structure.

Steel I-Beam Applications

- Single clamp and wing nut design.
- Adjustments made from top of beam.
- Fits flanges 6 in.-12 in. wide, 2-1/4 in. thick.
- Optional bases for 18 in., 24 in. and 36 in. widths.

Concrete rebar & shear stud applications

- Simply attach with torque wrench.
- Simple chain tie-back connection.
- Fits 1/2 in.-1 in. diameter (#4-#8 rebar) and 4 in.-12 in. center to center.

3M™ DBI-SALA® SecuraSpan™ Horizontal Lifeline Systems

Complete single span system includes two stanchions (7400047) and cable assembly with tensioner and Zorbit™ Energy Absorber. 60 ft. (18.3 m)



Selection guide:

	20 ft.	30 ft.	40 ft.	50 ft.	60 ft.	Stanchion	Tie-Back Base
I-Beam	7400420	7400430	7400440	7400450	7400460	7400047	-
Rebar/Shear Stud	7400620	7400630	7400640	7400650	7400660	7400215	7400214

Systems shown with intermediate stanchion—must order separately.

Systems shown with intermediate stanchions—sold separately.

3M™ DBI-SALA® SecuraSpan™ Loop Rebar Horizontal Lifeline Systems

These easy-to-install complete single-span systems include two stanchions and cable assembly with tensioner and Zorbit™ Energy Absorber.



Selection guide:

20 ft.	30 ft.	40 ft.	50 ft.	60 ft.	Stanchion
7400320	7400330	7400340	7400350	7400360	7400045

System shown with intermediate stanchion—sold separately.

3M™ DBI-SALA® SecuraSpan™ I-Beam System Components

7400087

Perpendicular I-Beam System Components Stanchion with Perpendicular I-Beam Base
No tie back, fits 8 in.-14 in. flange.



7400086

Perpendicular I-Beam Base Only
Fits 8 in.-14 in. flange.



7400089

Perpendicular Pass-Through Kit

Selection guide:

Stanchion with I-Beam Base	6 in.-12 in. Flange	12 in.-18 in. Flange	18 in.-24 in. Flange	24 in.-36 in. Flange
	7400047	7400055	7400056	7400057
I-Beam Base Only	6 in.-12 in. Flange	12 in.-18 in. Flange	18 in.-24 in. Flange	24 in.-36 in. Flange
	7400052	7400065	7400066	6700067
Stanchion with I-Beam Base for 3-3/8 in. Thick Flange	Fits up to 3-3/8 in. thick, 6 in.-12 in. wide	Fits up to 3-3/8 in. thick, 12 in.-18 in. wide	Fits up to 3-3/8 in. thick, 18 in.-24 in. wide	Fits up to 3-3/8 in. thick, 24 in.-36 in. wide
	7400015	7400032	7400033	7400034

Lifeline options for all systems—cable assembly with turnbuckle and Zorbit™ Energy Absorber are available in 10 ft. increments. Cable assemblies over 60 ft. include two Zorbit™ Energy Absorbers.

3M™ DBI-SALA® SecuraSpan™ Rebar System Components

7400215

Stanchion with Rebar/Shear Stud Base
Pass-through and end anchor brackets.

7400053

End-Anchor Retro-Fit Kit
With rebar/shear stud base, tie-back assembly, end-anchor and pass-through bracket.

7400054

Intermediate Retro-Fit Kit
With rebar/shear stud base and pass-through bracket.

7400214

Tie-Back Base and Chain Assembly



3M™ DBI-SALA® SecuraSpan™ Loop System Components

7400045

Stanchion with Loop Rebar Base and Pass-Through Bracket



3M™ DBI-SALA® EZ-Line™ Retractable Horizontal Lifeline (HLL) System



7605060

This is a lightweight, easy-to-use lifeline system that you can install, remove and store quickly.

- Built-in winch.
- Customizable in any length up to 60 ft.
- Built-in pre-tension and impact indicators.
- Two worker capacity.

7600002

Replacement EZ-Line Handle Assembly

See product instruction manual for complete clearance information.

3M™ DBI-SALA® Sayflin™ Cable Horizontal Lifeline (HLL) Systems

These systems are highly portable and can be used for situations where welding, sparks or harsh environments are present, or where minimum clearance exists.

- Includes cable lifeline assembly with wedge grip termination, tensioner and 3M™ DBI-SALA® Zorbit™ Shock Absorber.
- Durable all-metal system can be left in place for long periods.
- Easy to relocate at next location or site.
- Use with any 5,000 lb. anchorage device.
- Two worker capacity.

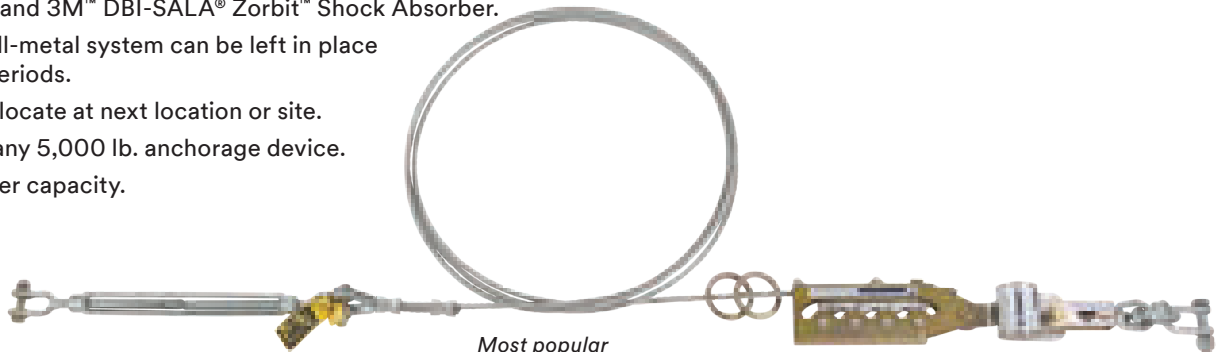

Most popular length

Selection guide:

20 ft.	30 ft.	40 ft.	50 ft.	60 ft.	70 ft.	80 ft.	90 ft.	100 ft.
7602020	7602030	7602040	7602050	7602060	7602070	7602080	7602090	7602100

See product instruction manual for complete clearance information.

3M™ DBI-SALA® Sayflin™ Synthetic Horizontal Lifeline Systems

Lightweight, easy-to-install and portable systems that can be used for maintenance, bridge work, construction and general industry applications.

- Installs without special tools or equipment.
- Easy to relocate to next location or site.
- Kernmantle rope lifeline with tensioner and shock absorber.
- Capacity of two workers.



Selection guide:

Most popular length

20 ft.	30 ft.	40 ft.	50 ft.	60 ft.	70 ft.	80 ft.	90 ft.	100 ft.
7600502	7600503	7600504	7600505	7600506	7600507	7600508	7600509	7600510

See product instruction manual for complete clearance information.

3M™ DBI-SALA® SecuraSpan™ Pour-in-Place Horizontal Lifeline Systems

These lightweight and portable systems install to column tops, providing an overhead tie-off point during the decking process. Complete system includes two stanchions (7400203), and cable assembly with tensioner and 3M™ DBI-SALA® Zorbit™ Energy Absorber.

- Fast and easy setup and use.
- Single and multi-span options with unlimited length.
- Pass-through design provides protection for up to two workers.

Selection guide:

20 ft.	30 ft.	40 ft.	50 ft.	60 ft.
7400220	7400230	7400240	7400250	7400260

See product instruction manual for complete clearance information.



3M™ DBI-SALA® SecuraSpan™ Pour-in-Place Accessories

7400203
Stanchion Assembly
7 ft. 6 in. tall.



7400200
Intermediate Bracket

Allows system to be configured into multi-span type



7400201
Concrete Sleeve

For pour-in-place post horizontal lifeline systems.



7400211
Clamp-On Vertical Base
Clamps to existing vertical steel and concrete structures, zinc-plated steel construction.



7400218
Bolt-On Vertical Base
Bolts to vertical steel and concrete structures, zinc-plated steel construction.



7400222
Weld-On Vertical Base
Welds to vertical steel structures, steel C-channel construction.



8530267
Bolt-On Floor Base
Bolts to steel and concrete horizontal surfaces, zinc-plated steel construction.



3M™ DBI-SALA® Horizontal Lifeline Components

3M™ DBI-SALA® Zorbit™ Energy Absorber Kits

- Allows use of standard 5,000 lb. rated anchors.
- Lightweight, compact and easy to set up and use.
- Simple design makes integration easy.

Accessory products:

1. Cable clips - **9501563**
2. O-rings - **9503880**
3. Thimbles - **9506596**
4. Turnbuckle - **7002050**
5. Wedge Grip Horizontal Lifeline Termination Device - **7608008**
6. Zorbit™ Energy Absorber - **7401013**



Selection guide:

7401013	7401031	7401032	7401033	7600580
Zorbit™ Energy Absorber only	Zorbit™ Energy Absorber with 2 shackles, bolts, nuts	Zorbit™ Energy Absorber with 2 shackles, bolts, nuts, turnbuckle	Zorbit™ Energy Absorber with 3 shackles, bolts, nuts, turnbuckle, thimbles, cable clips	Zorbit™ Energy Absorber with 3 shackles, bolts, nuts, turnbuckle, thimbles, cable clips with wedge grip, 2 O-rings

3M™ DBI-SALA® Horizontal Lifelines

These horizontal lifeline systems aren't just easy to use—they're easy to install with the support of our network of certified installers. Call customer service for more information.

- Pre-engineered or customized.
- Provides continuous fall protection.
- Shouldn't conflict with other building safety systems.

See page 35 for more information on 3M™ DBI-SALA® Engineered Systems.

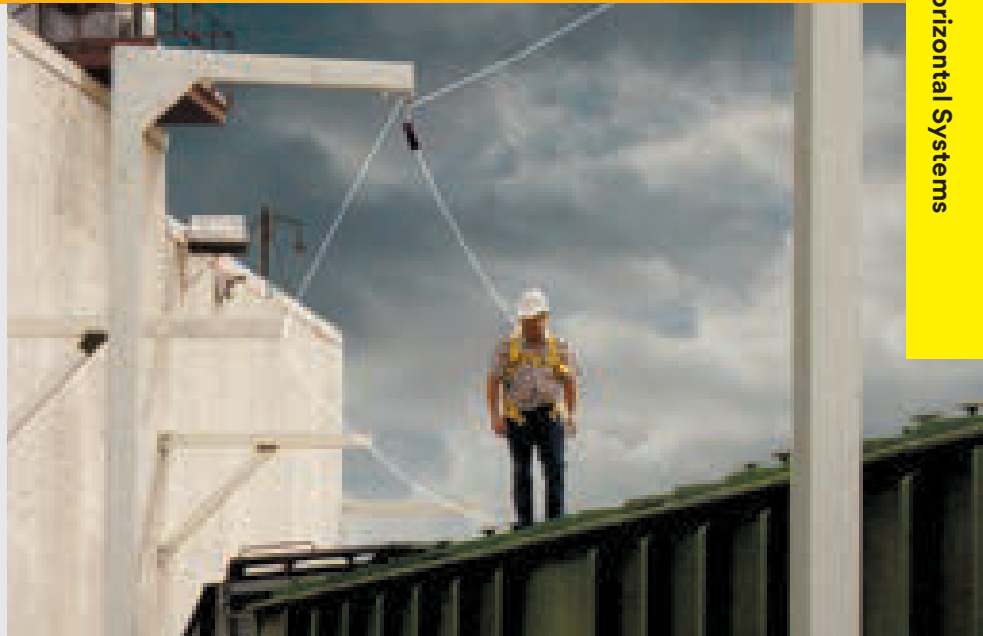

Comparison guide:

	EZ-Line™	Sayflite™ Synthetic	Sayflite™ Cable	Multi-Span	SecuraSpan™
Maximum Length	60 ft.	100 ft.	100 ft.	180 ft.	600+ ft.
Maximum Span Length	60 ft.	100 ft.	100 ft.	30 ft.	60 ft. w/ stanchions, 100 ft.
Minimum Anchorage Strength	5,000 lbs.	3,600 lbs.	5,000 lbs.	5,000 lbs.	5,000 lbs.
Multi-spans Allowed	Yes	No	No	Yes	Yes
Maximum Number of Spans	Many	100 ft.	1	12	Many
Maximum Users on System	6	2	2	2	6
Maximum Users on Span	2	2	2	2	2
420 lb. Capacity	Yes, derate system to single person per span.				
Energy Absorber	Brake and reserve line Zorbit™ used on multi-span setups	In-line energy Shock Pack	1 Zorbit™ for 60 ft. span or less, 2 Zorbit™ are required for more than 60 ft.	1 Zorbit™ for 30 ft. single span, 2 Zorbit™ for multiple spans	1 Zorbit™ for up to 60 ft. single span, use second Zorbit™ for multiple spans
Fall Clearance Saved (When changing from 60 ft. span to 30 ft. span)	2 ft.	7 ft. 2 in.	3 ft. 11 in.	1 ft. 4 in. for 10 ft.-30 ft. span	3 ft. 11 in.
Amount of Slope Allowed	15 degrees	5 degrees	5 degrees	5 degrees	5 degrees
System Must Limit Average "Arresting Forces To"	900 lbs. or less				
Proper Tensioning of Cable	Unit handle will "click" at correct tension	Turn tensioning nut until tensioner slips, 350-450 lbs. of tension	Turn turnbuckle until tension gauge reads "OK." 6 in. or less sag wire w/o any weight	Turn turnbuckle until 2 in. or less sag in wire at mid-point w/o any weight	Turn turnbuckle until 6 in. or less sag in wire w/o any weight
Inspection	User should inspect before each use. Annual inspection by competent person. Qualified person should be involved with installation and use per OSHA.				

3M™ DBI-SALA® Sayflin™ Multi-Span Horizontal Lifeline Systems

Sayflin™ Horizontal Systems are designed for “off-the-shelf” user installation. Custom sizes are available, call customer service for more information.

- Completely customizable, including span length, total system length and even final installation position.
- Provides 100% continuous fall protection for two workers when they are properly attached to the appropriate lifeline.
- One-piece sleeve bypasses intermediates and freely moves with you.
- System includes lifeline, intermediate bracket (one per 30 ft. span), termination hardware, tensioner and two Zorbit™ Energy Absorbers.



Selection guide:

	20 ft.	40 ft.	60 ft.	80 ft.	100 ft.	120 ft.	140 ft.	160 ft.	180 ft.
Galvanized	7603020	7603040	7603060	7603080	7603100	7603120	7603140	7603160	7603180
Stainless Steel	Contact Customer Service for part numbers.								

Sayflin sleeve sold separately.

Sayflin™ Accessories

7608001

Intermediate Bracket
For multi-span systems.



7608002

Sayflin™ Sleeve
For Sayflin™ Multi-Span Horizontal Lifeline system.



Security and confidence at height.

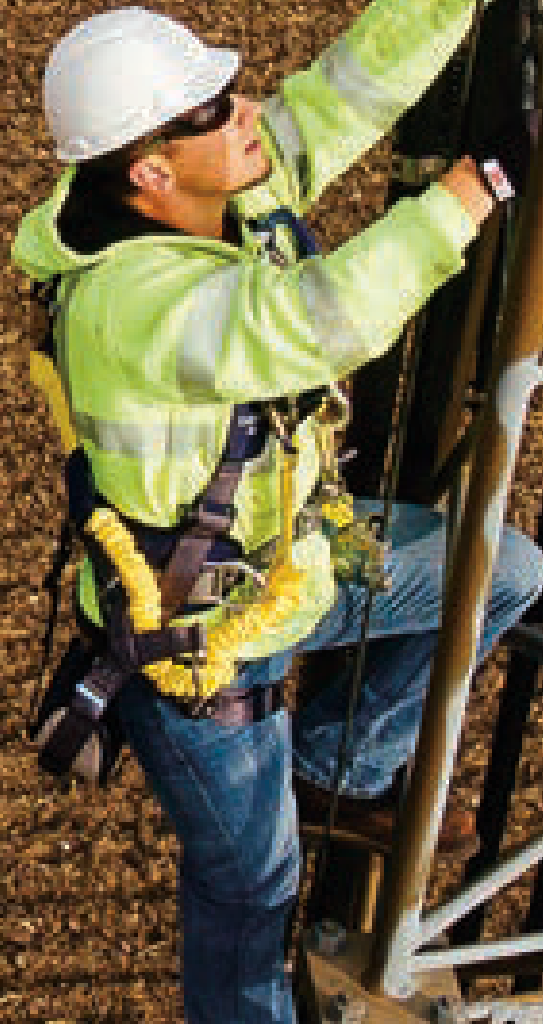

3M™ DBI-SALA® Vertical Systems are designed to complement your ability to work while meeting all applicable OSHA and ANSI standards.

Vertical fall protection systems allow workers to move up and down the entire height of the lifeline rather than having to disconnect and find new tie-off points along the way. Some important considerations when selecting a system include:

Portable or permanent

Temporary jobs require lightweight and easy-to-use portable systems with synthetic lifelines that can be moved from one location to another. For structures that are accessed often, a permanent solution is a better choice.

Mobile or fixed

Mobile rope grab or ladder sleeve designs automatically follow the user for easy operation. Fixed devices allow the user to fix the unit in place for positioning or restraint applications.

The rules have changed

OSHA's final rule to update general industry walking-working surfaces and fall protection standards (29 CFR 2910) means that outdoor advertising fixed ladders over 24 feet will require ladder safety or personal fall arrest systems. It also means that fixed ladder cages and wells must be phased out and replaced by ladder safety or fall arrest systems by 2036.

3M™ DBI-SALA® Lad-Saf™ Flexible Cable Ladder Safety Systems

Help to make your structures safe and accessible. Optional configurations include welded or bolted, straight or curved ladders, wood, concrete or steel structures and a variety of rung clamp sizes and styles. These systems are a versatile and economical solution for many applications.

1 Standard top bracket

Galvanized top bracket with mounting hardware. For systems up to 499 ft. (152 m) high, fits up to 1-1/8 in. (2.85 cm) rung diameter and attaches to three rungs. Includes built-in energy absorber.

2 Standard bottom bracket

Fits up to 1-1/8 in. (2.85 cm) rung diameter and attaches to two rungs. Galvanized bottom bracket includes built-in tension indicator.

3 Cable guide

Non-metallic cable guide with mounting hardware. For systems up to 199 ft. (60.6 m), fits up to 1-1/8 in. (2.85 cm) rung diameter. Recommend one every 25 ft. (7.6 m)

4 Cable lifeline

Galvanized cable, 3/8 in. (9.5 mm) diameter, 1 × 7 type. Last three digits in part number indicate length.

5 Lad-Saf X3 Detachable Cable Sleeve

Climbing sleeve for better climbing performance and fall protection.



Easy to climb

The Lad-Saf X3 Detachable Cable Sleeve automatically follows the climber during ascent or descent. In the event of a fall, the sleeve immediately locks onto the cable and remains locked until the user can regain their footing.

Tension indicator

Integrated tension-indicating bottom bracket takes the guesswork out of installation.

Customizable

Hundreds of different brackets, styles and configurations to suit almost any application.

Corrosion-resistant construction

Galvanized and stainless steel construction stands up to harsh environments for added longevity.

Shock-absorbing design

Integrated shock-absorbing top bracket reduces forces imposed on ladder structure during a fall.

Protected from wear

Intermediate cable guides help prevent cable wear against the ladder while permitting the climber to bypass without disconnecting.



6100090

3M™ DBI-SALA® Lad-Saf™ Bottom Bracket

Standard galvanized bottom bracket with mounting hardware. Fits up to 1-1/8 in. (2.85 cm) rung diameter, attaches to two rungs, built-in tensioning device.



6100400

Lad-Saf Cable Guide

Non-metallic cable guide with mounting hardware. For systems up to 199 ft. (60.6 m), fits up to 1-1/8 in. (2.85 cm) rung diameter. 3M recommends one every 25 ft. (7.6 m)

6100515 Cable Guide (L-shaped) and hardware for systems over 200 ft. (61 m)

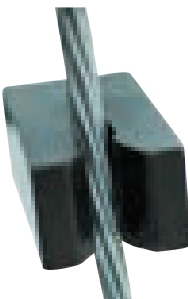

Lad-Saf Cable Lifeline

Durable high strength steel construction. Galvanized construction stands up to harsh environments for maintenance free longevity.



6116280

Lad-Saf Top Bracket

Standard galvanized top bracket with mounting hardware. For systems up to 499 ft. (152 m) high, fits up to 1-1/8 in. (2.85 cm) rung diameter, attaches to three rungs, built-in energy absorber.

6116410 Standard Top Bracket and hardware for systems over 500 ft. (152.4 m)

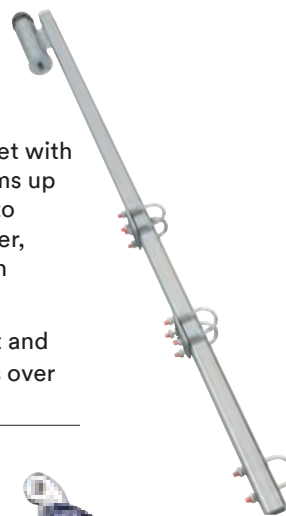

6160054

Lad-Saf X3 Detachable Cable Sleeve

For use with 3/8 in. (9.5 mm) diameter 1 × 7 or 7 × 19 solid core cable. Comes with 2000112 carabiner. Meets OSHA and ANSI standards.



6160030

Lad-Saf X2 Detachable Cable Sleeve

Sleeve with carabiner, dual independent locking system, fits 3/8 in. (9.5 mm) and 5/16 in. (8 mm) diameter 1 × 7 or 7 × 19 solid core cable.



Cable Lifeline general specifications and materials

	6110XXX	6152XXX	6130XXX	6154XXX
Diameter	3/8 in. (9.5 mm)	3/8 in. (9.5 mm)	3/8 in. (9.5 mm)	3/8 in. (9.5 mm)
Strand	1 × 7	1 × 7	7 × 19	7 × 19
Steel	Galvanized	Stainless	Galvanized	Stainless
Preformed	Left, Regular Lay	Left, Regular Lay	Right, Regular Lay	Right, Regular Lay
Compliance	ASTM A475	ASTM A368	RR-W-410	RR-W-410
Breaking strength	15,400 lbs. minimum	18,000 lbs. minimum	14,400 lbs. minimum	12,000 lbs. minimum

Last three digits in part number indicate length.

System Kits

System Kits include 6116280 Top Bracket, 610090 Bottom Bracket, 3/8 in. 1 × 7 galvanized cable with designated length and cable guides where required.

- 6100897 17 ft. Lad-Saf System Kit
- 6100898 20 ft. Lad-Saf System Kit
- 6100877 30 ft. Lad-Saf System Kit
- 6100909 45 ft. Lad-Saf System Kit
- 6100876 100 ft. Lad-Saf System Kit

Coming Soon:

3M™ DBI-SALA® Lad-Saf™ Flexible Cable Vertical Safety System

Redesigned to streamline installation with up to 72% fewer loose components compared to current generation. ANSI Z359.16 compliant.

3M™ DBI-SALA® Lad-Saf™ Bolt-On Ladder Safety System



Part numbers will vary based on tower design. Call customer service for detailed parts list for telecommunications structures.



Steel Pole Ladder Safety System

6116250

Top Bracket for Steel Pole
Weld-on for monopole towers.

6116261

Top Bracket for Steel Pole
Bolt-on for monopole towers.

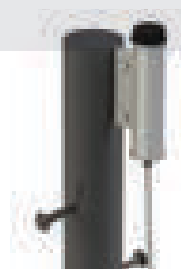

Angle iron, clamp-on, and steel pole weld-on systems also available. Call us today.

Ladder Accessories

6116336

Grab Bar Extension

Slides into Top Bracket (6116054) of fixed ladder safety system and provides the user with a tie off point (for lanyard) when connecting or disconnecting from the system's lifeline.

6116054

Top Bracket Assembly

For use with 6116336 (replaces standard 6116280 Top Bracket).



6116026

Ladder Anchor Post

Galvanized removable extension with eye-bolt anchor to attach 3-way SRL.

6116027

Galvanized Bottom Mounting Bracket

Attaches 6116026 to ladder.



5901980

Ladder Gate

Designed to help protect you from the dangers (and liability) of unauthorized ladder access.

Fits ladder widths up to 20 in. (50.8 cm). Mounting hardware included.

Aluminum construction 8 ft. (2.4 m) height x 36 in. (91.4 cm) width.



3M™ DBI-SALA® Rigid Rail Ladder Safety Systems

The Rigid Rail System consists of top and bottom entry/exit gates, rail joints and multiple mounting bracket options designed to mount the rigid aluminum rail to the structure. You can configure to an existing ladder or customize a system with integrated ladder pegs when no ladder exists. Various clamps are available to attach to almost any structure.

Shock-absorbing design

Integrated energy absorber reduces forces imposed on system and worker.

Easy to climb

Automatically follows the user and locks in the event of a fall.

Ladder rung clamps

A variety of rung clamps designed for installation at multiple anchor points along the system length.

Customizable

Different clamps and configurations available.

Corrosion-resistant construction

Stands up to harsh environments for added longevity.

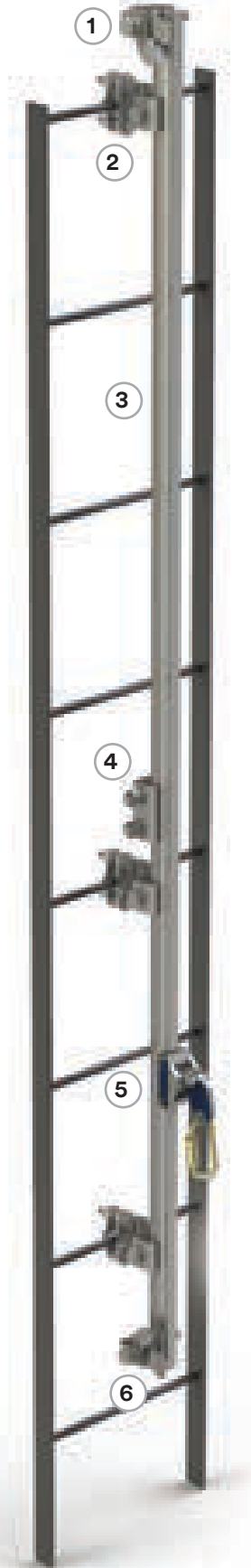

Standard Ladder

- 1 6000352**
Top Ladder Rail Gate
Allows user to easily attach shuttle to the system and helps prevent accidental removal from the system.
- 2 6000120**
Ladder Rung Clamp
Attaches rail to ladder structure. Use within 1 ft. (0.3 cm) of rail splice and one at least every 5 ft. (1.5 m)
- 3 6000033**
Standard Rail
Anodized extruded aluminum rail x 6.56 ft. (2 m)
6000031 3.25 ft. (1 m) Rail Section
6000032 9.84 ft. (3 m) Rail Section
- 4 6000100**
Rail Joint
Attaches two rail sections together.
- 5 6000377**
Shuttle
Climbing shuttle automatically follows user and locks onto rail during a fall.
- 6 6000375**
Bottom Standard Rail Gate
Allows user to easily attach shuttle to the system and helps prevent accidental removal from the system.

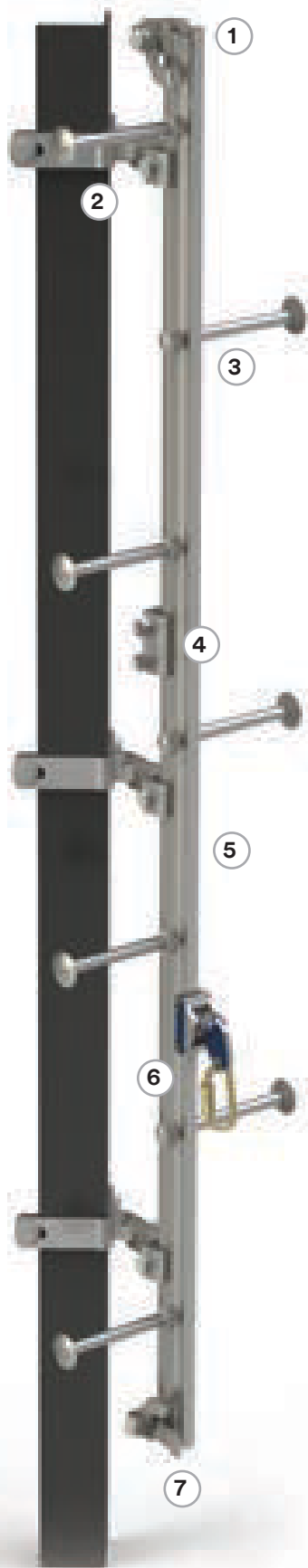

Integrated Ladder

- 1 6000354**
Top Ladder Rail Gate

Allows user to easily attach shuttle to the system and helps prevent accidental removal from the system.
- 2 6000132**
Angle Iron Clamp

Attaches rail to angled iron structure. Other clamp styles available.
- 3 6000298**
Step Bolt

Attaches to ladder rail to create climbing pegs.
- 4 6000100**
Rail Joint

Attaches two rail sections together.
- 5 6000307**
Ladder Rail

Anodized extruded aluminum rail with step bolt holes x 7.87 ft. (2.4 m)

6000301	1.96 ft. (0.6 m) Ladder Rail Section
6000302	2.95 ft. (0.9 m) Ladder Rail Section
6000303	3.93 ft. (1.2 m) Ladder Rail Section
6000304	4.92 ft. (1.5 m) Ladder Rail Section
6000306	5.90 ft. (1.8 m) Ladder Rail Section
- 6 6000377**
Shuttle

Climbing shuttle automatically follows user and locks onto rail during a fall.
- 7 6000375**
Bottom Ladder Rail Gate

Allows user to easily attach shuttle to the system and helps prevent accidental removal from the system.

3M™ DBI-SALA® Climb Assist Systems

Powered Systems

Climb internal ladders on wind energy towers smarter with our climb assist system. Designed to be used in conjunction with a ladder safety system, it includes top and bottom pulley assemblies, wire cable, wire cable grip, motor control assembly and cable tensioning system.

Adjustable force settings

Provides five discrete force level settings.

Adapts to environment

Unique “adaptive” motor control system adjusts to conditions and climbing speed.

Effortless ascent and descent

Personalized system adjustment of 55-120 lbs. (25-55 kg) for a variety of user weights.

Simple installation

Plug-n-play portable motor control unit design enables simple installation to cable tensioning unit.

Global compatibility

System accommodates a power supply range of 110-240 Vac, 50-60 Hz.

Maximum portability

20 lb. (9 kg) portable motor control unit is easily transported to support multiple systems and towers.

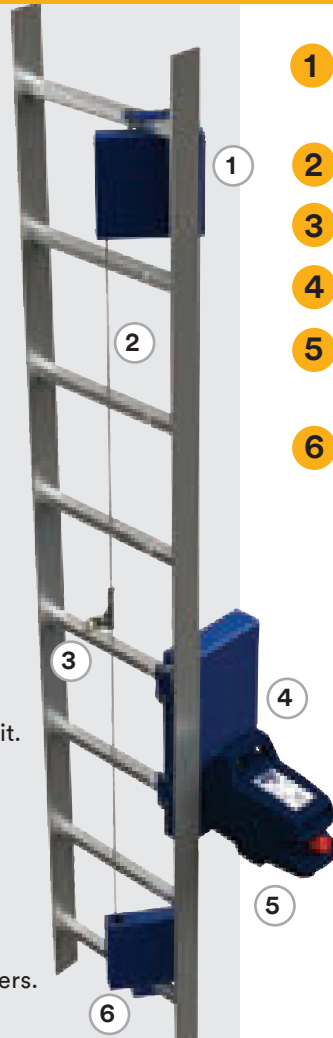

- 1 Top bracket pulley assembly
- 2 Wire cable
- 3 Wire cable grip
- 4 Cable tensioning system
- 5 Plug-n-play motor control assembly
- 6 Bottom bracket pulley assembly



Tower Kit



- 1 **6160039**
Tower Kit
- 2 **6160041**
Tensioning Assembly

- 3 **6160040**
Top & Bottom Bracket
Pulley Assemblies

- 4 **6100031**
Wire Cable Swage
Connections

- 5 **6160027**
Wear Pad Kit
Nylon pads, stainless steel screws,
drill bit and tap.

- 6 **6160028**
Wire Cable
3/16 in. (4.8 mm) x 656 ft. (200 m). 7 x
19 strand core. Galvanized steel wire.



- 6160051**
Motor Control Assembly
Lightweight and portable at
approximately 20 lbs. (9 kg).
Globally compliant 120-240
Vac, 50-60 Hz. Operating
temperature range: -22° F-131° F
(-30° C-55° C). IP54 rating.

9506929 Power Cord
(NEMA 5-15P)

Accessories



6160026
Wire Cable Grip with Carabiner
Carabiner: 11/16 in. (17.7 mm) gate opening, 3,600 lb. (16 kN) gate strength, with captive eye installed. Wire Cable Grip: 3/16 in. (4.8 mm) cable sleeve.



6160024
Twin-Leg Lanyard Assembly with Wire Cable Grip (optional)
Two Carabiners: 11/16 in. (17.7 mm) gate opening, 3,600 lb. (16 kN) gate strength, with captive eye installed. Wire Cable Grip: 3/16 in. (4.8 mm) cable sleeve. Webbing: Yellow nylon, 7/8 in. (22.2 mm) width x 11-1/4 in. (285.8 mm) length.



1113452
ExoFit NEX™ Powered Climb Assist Harness
Wind energy harness with 16 in. (406 mm) climb assist straps located off hips (XLarge).
1113449 Small
1113450 Medium
1113451 Large
1113453 2X



1113457
ExoFit NEX™ Powered Climb Assist Construction Style Harness
Wind energy harness with 16 in. (406 mm) climb assist straps located off hips (XLarge).
1113454 Small
1113455 Medium
1113456 Large
1113458 2X

For use with Wire Cable Grip with Carabiner (6160026)—order separately.

SSB Systems

Supports workers' motions and provides fall protection while climbing tall ladders and towers. Great for on-shore and off-shore drilling platforms.

Added safety

Counterweight includes a runaway brake as a backup safety measure.

Ultimate flexibility

No limit to length of system.

Enhanced durability

Aluminum housing and steel drum resist corrosion.

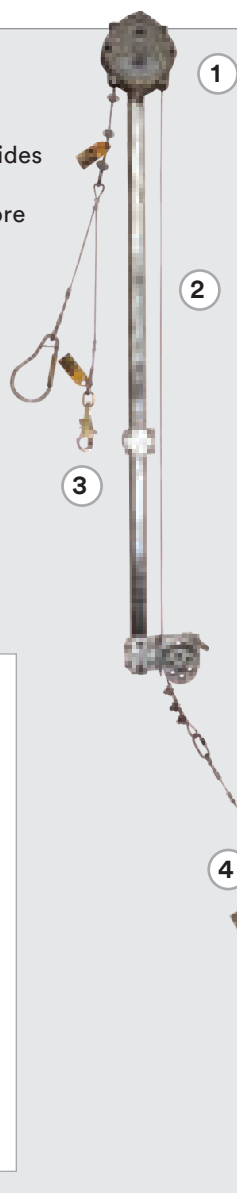
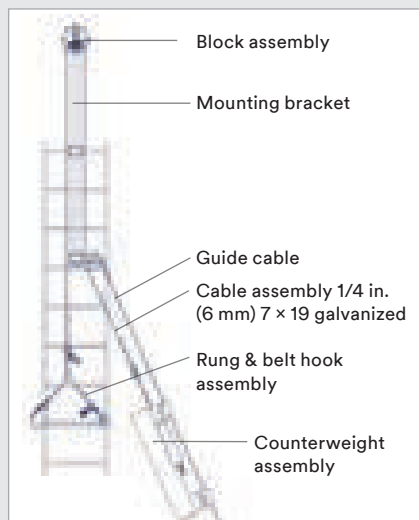

1 3511063

SSB Safety Block

Climb assist main block pulley assembly.

2 3512XXX

Lifeline Assembly

Galvanized 1/4 in. (6.3 cm) 7 × 19 cable assembly with rung and belt hook (last three digits in part number signify length).

3530XXX Stainless Steel Lifeline Assembly

3 3511783

Mounting bracket

Attaches safety block to structure. Fits round rungs up to 3/4 in. (1.9 cm) diameter or square rungs up to 9/16 in. (1.4 cm) per side.

3511785 Mounting bracket, fits round rungs over 3/4 in. (1.9 cm) up to 1-1/2 in. (3.8 cm) diameter or square rungs over 9/16 in. and up to 1-1/2 in. (3.8 cm) per side.

3511645 Rung Belt Assembly

4 3511598

Counterweight Assembly

80 lb. (36.3 kg) counterweight with integrated runaway brake system.

3M™ DBI-SALA® Rope Grabs

5000335

3M™ DBI-SALA®
Lad-Saf™ Mobile
Rope Grab

Detachable design can be attached or removed anywhere along lifeline. For use on 3M approved 5/8 in. (16 mm) polyester/polypropylene rope lifeline. Use with 3 ft. (0.9 m) shock-absorbing lanyard.



5002045 Lad-Saf Rope Grab with attached EZ-Stop™ Shock-Absorbing Lanyard x 3 ft. (0.9 m)

5001442 Lad-Saf Rope Grab for use on 3M approved 3/4 in. (19 mm) polyester/polypropylene rope lifeline x 3 ft. (0.9 m). For use with 3 ft. shock-absorbing lanyard.



1246037

3M™ DBI-SALA®
EZ-Stop™ Rope Adjuster

Installs at top or bottom of the lifeline. Durable and lightweight, corrosion resistant construction. For use on 3M approved 5/8 in. (16 mm) rope lifeline. Equipped with RFID.



5000338

Lad-Saf Wire Rope Grab

Manual design for use in extremely abrasive or corrosive environments. For use on 3M approved 3/8 in. (9.5 mm) 7 x 19 galvanized or stainless steel cable. Use with 4 ft. (1.2 m) shock-absorbing lanyard.

5000400

Rope Grab Kit

Complete rope grab system in a bag for convenient fall protection compliance on the job. Kit includes:

Mobile Rope Grab (5000335)

Shock-Absorbing Lanyard (1246012)

Lifeline x 50 ft. (1202794)

Counterweight (5901583)

Tie-Off Adapter (1003000)

Carrying Bag (9511597)

5000401 Rope Grab Kit with 100 ft. (30 m) Lifeline (1202844) and Carrying Bag. (9503806)



5901583

Counterweight

5.7 lb. (2.6 kg) flexible counterweight keeps lifeline taut. Heavy-duty nylon construction. Built-in web loop for easy attachment to lifeline. Compact and portable design. Equipped with RFID.



Rope Lifelines

Blended Rope Lifeline Assemblies feature additional abrasion and UV resistance for added durability, longevity and safety. Various styles and lengths are available to suit any need.



Lifeline material	Hook style	Lifeline diameter (inch/mm)	25 ft. lifeline (8 m)	30 ft. lifeline (9 m)	50 ft. lifeline (15 m)	75 ft. lifeline (22 m)	100 ft. lifeline (30 m)	150 ft. lifeline (46 m)
Polyester/polypropylene blend	Snap hook at one end	5/8 in. (15.9 mm)	1202742	1202754	1202794	1202821	1202844	1202879
		3/4 in. (19.05 mm)	1202739	1202750	1202785	1202818	1202838	1202877
	Snap hook at both ends	5/8 in. (15.9 mm)	1202740	1202753	1202790	1202823	1202842	1202878

Custom sizes available.

3M™ DBI-SALA® Engineered Systems



3504550

3M™ DBI-SALA® Ultra-Lok™ RSQ Self-Retracting Lifeline
Dual mode RSQ allows for a simple, effective rescue should a fall event occur.

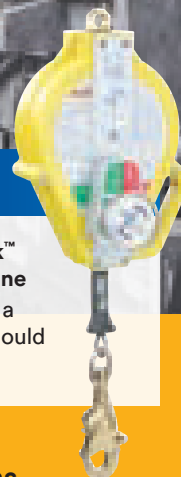

Flexibility for demanding worksites.

Meet the fall protection needs of your unique worksite with a safety system designed specifically for your application. A 3M certified specialist will help you with options for the selection, installation, training and use of your engineered system. Contact customer service to find a certified specialist to assist you.

Overhead Applications

- Specifically designed to meet the needs of transport and industrial applications.
- Can be used for work at height on trains, trucks, aircraft, crane walkways and loading bays.
- Supports self-retracting lifelines and controlled rate descent devices up to 33.1 lbs.
- Allows up to 200 ft. single span for one user and up to 100 ft. single span for multiple users.*

Contact EngineeredSystems-FP@mmm.com to find a certified specialist today.

**The number of system users and span lengths must be verified by the calculation software.*

3M™ DBI-SALA® Engineered Systems



3500214

3M™ DBI-SALA® Nano-Lok™ edge Quick-Connect Self-Retracting Lifeline
8 ft. (2.4 m) lifeline with 3/16 in. (5 mm) galvanized steel wire rope and aluminum captive carabiner, quick connector for harness mounting.



Wall and Floor Applications

- Engineered lifeline systems can be used for modern building projects, refurbishments and industrial safety applications.
- Can be fitted to steel beams, concrete and brickwork.
- Suitable for use on older roof constructions in conjunction with fabricated anchor posts.*

**Not supplied by 3M Fall Protection.*

Contact **EngineeredSystems-FP@mmm.com** to find a certified specialist today.

3M™ DBI-SALA® Flexiguard™ Solutions



Unique solutions for unique applications.

No two jobs or job sites are the same. Whether you're working on airplanes or oil rigs, you need a secure anchor point to get the job done. 3M™ DBI-SALA® Flexiguard™ Solutions are designed to help provide large, safe working areas with overhead anchor points for one or more workers in a variety of challenging situations. These systems are versatile, lightweight and exceptionally mobile with minimal personnel input. Rugged enough for harsh indoor or outdoor applications, these systems are great for the transportation, construction, oil and gas, mining and utilities industries.

3M™ DBI-SALA® Engineered Modular Unit

- Three base mounting* options to fit almost any need.
- 360-degree rotational mast—rotation handle included for turning system into working position.
- Rotation locking system enables fixed mast position or an adjustable rotation range.
- Glide rail and trolley keeps anchor point overhead.
- Easy to move with a pallet jack or forklift.
- OSHA compliant.*

It's easy to spec your own 3M™ DBI-SALA® Engineered Modular Unit:

1. Choose from several fixed position and portable counterweighted base options.
2. Select an adjustable mast assembly—10-15 ft., 13-20 ft. or 15-25 ft.
3. Add accessories like a lifting ring kit, stabilizing jack kit or rescue mounting kit.

For ordering information, contact your local sales representative or call customer service at 800-328-6146 (Opt. 1).

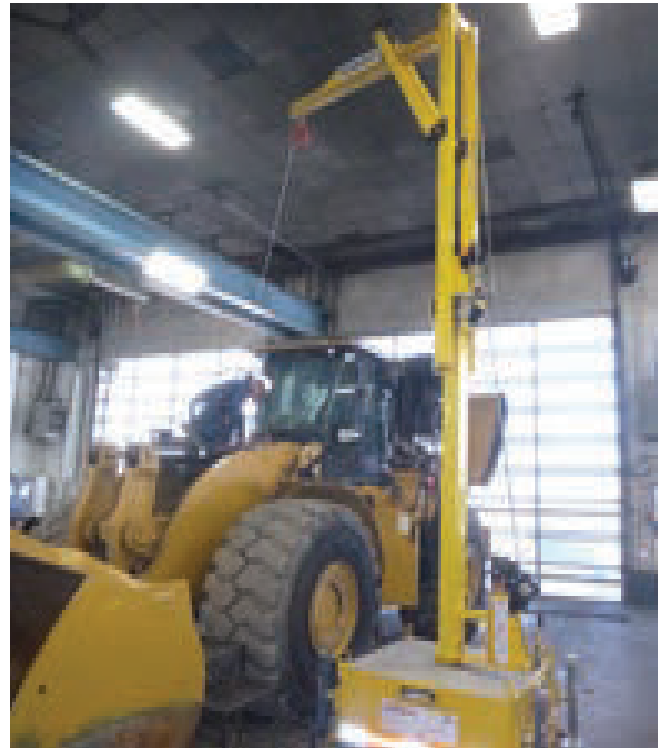

Fixed Height System

Anchor height	Offset	# of Users	Part #
21 ft.	7 ft.	1	8530571

Adjustable Height Jib Systems

Anchor height	Offset	Concrete	# of Users	Part #
10 ft.-15 ft.	7 ft.	n/a	1	8530557
13 ft.-20 ft.	7 ft.	n/a	1	8530558
15 ft.-25 ft.	7 ft.	n/a	1	8530559
15 ft.-24 ft.	7 ft.	without	2	8530538**
15 ft.-24 ft.	7 ft.	with	2	8530768**

**Indicates a complete system that includes counterweight base.

Base Configurations

Base type	Concrete	Part #
Flush Floor Mount	n/a	8530564
Top Floor Mount	n/a	8530565
5,000 lb. Counterweight	with	8530566
5,000 lb. Counterweight	without	8530621
7,700 lb. Extended Reach Counterweight	with	8530570
7,700 lb. Extended Reach Counterweight	without	8530666



Accessory	Part #
Lifting Ring Kit	8530777
Stabilizing Jack Kit	8530563
Rescue Kit	8530677

*Complies with requirements of OSHA 29 CFR 1910.140 and 1926.502.

3M™ DBI-SALA® SafRig™ System

- Excellent for applications that require a large work area in a limited space.
- Smaller frame allows trucks to be parked side-by-side without requiring the vehicle to act as an anchoring force.
- 360-degree rotational boom provides 5 ft. working offset—periscoping handle included.
- Counterweight base solutions available with or without concrete.
- OSHA compliant.*

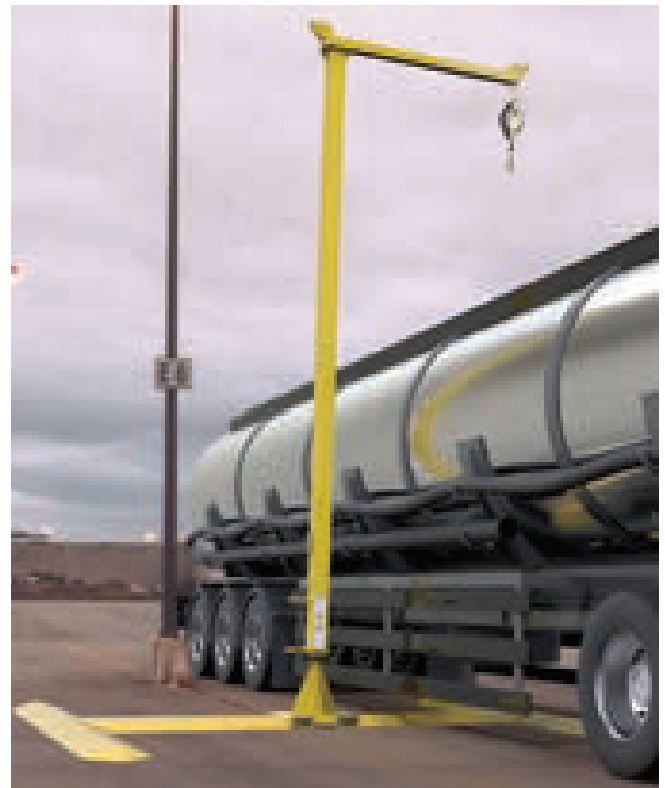

8530607

SafRig™ with Outrigger Base

Base	Anchor height	Offset	PPE Kit*	# of Users	Part #
15 ft. x 15 ft.	20 ft.	5 ft. 10 in.	not included	1	8530607
15 ft. x 15 ft.	20 ft.	5 ft. 10 in.	included	1	8530579

SafRig™ with Counterweight Base

Base	Anchor height	Offset	PPE Kit*	Concrete	# of Users	Part #
4 ft. 6 in.	20 ft.	5 ft. 9 in.	not included	with	1	8530606
4 ft. 6 in.	20 ft.	5 ft. 9 in.	not included	without	1	8530619
4 ft. 6 in.	20 ft.	5 ft. 9 in.	included	with	1	8530595
4 ft. 6 in.	20 ft.	5 ft. 9 in.	included	without	1	8530620

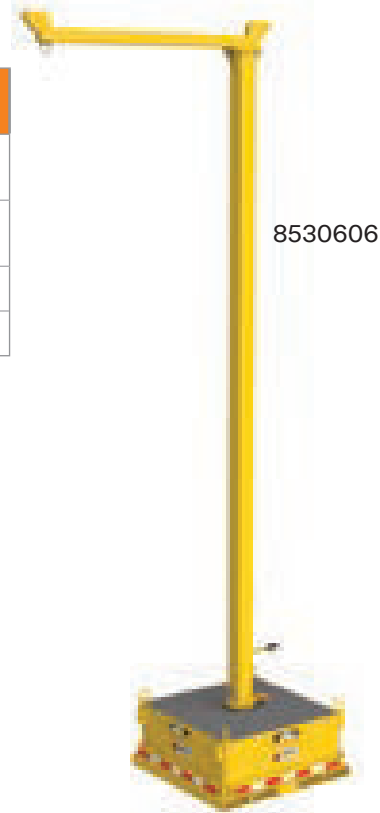

*Complies with requirements of OSHA 29 CFR 1910.140 and 1926.502.
 **PPE Kit includes: 20 ft. (6.1 m) 3M™ DBI-SALA® Ultra-Lok™ Self-Retracting Lifeline with 3M™ DBI-SALA® Saflok™ Carabiner and 25 ft. (7.6 m) tagline.

3M™ DBI-SALA® Counterweight Jib

- Great mobility and fall protection for one person.
- 360-degree rotating jib.
- Forklift pockets on all four sides for ease of movement and placement.
- Base includes four heavy-duty lifting rings.
- OSHA compliant.*

Counterweight Jib Systems

- Periscoping rotation handles included for turning the system into working position.
- Counterweight bases available with or without concrete.
- Glide rail and trolley keeps anchor point overhead.
- Offers increased offset over Engineered Modular Unit and 3M™ DBI-SALA® SafRig™ models.

Anchor height	Offset	Concrete	# of Users	Part #
16.75 ft.	8 ft.	without	1	8517750
16.75 ft.	8 ft.	with	1	8517751
20.67 ft.	8 ft.	without	1	8517752
20.67 ft.	8 ft.	with	1	8517753
23.67 ft.	8 ft.	without	1	8517754
23.67 ft.	8 ft.	with	1	8517755

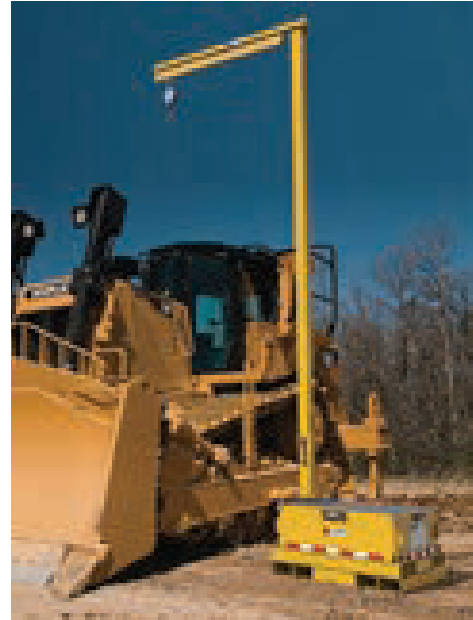

8517751

3M™ DBI-SALA® Pivoting Jib Booms

No-Base Systems

- Attaches to supporting, fixed structures (I-beam on the jobsite).
- Mounting clamps, plates and hardware included with systems.
- Rotates 180 degrees and locks every 7.5 degrees.
- Installed rail with trolley.

Boom height	Offset	# of Users	Part #
TBD by end user	20 ft.	1	8530433



8530433

3M™ DBI-SALA® Counterweighted System

- Helps easily create an overhead anchor point for multiple workers.
- Portable system lets you position close to the work surface without obstructing the equipment being accessed.
- Systems available with or without concrete counterweight on base.
- Great for areas with no overhead obstructions or door height restrictions.
- Includes one rail with two trolleys, heavy-duty leveling jacks and tag line assist.
- OSHA compliant.*

Anchor height	Rail width	Offset	Weighted	# of Users	Part #
22 ft.	32 ft.	8 ft.	not included	2	8517760
22 ft.	32 ft.	8 ft.	included	2	8517761
22 ft.	42 ft.	8 ft.	not included	2	8517762
22 ft.	42 ft.	8 ft.	included	2	8517763



8517760

*Complies with requirements of OSHA 29 CFR 1910.140 and 1926.502.

3M™ DBI-SALA® C-Frame System

- Designed to be moved manually or with a tow bar and service vehicle.
- Requires some clearance under equipment being accessed to accommodate the outrigger support legs.
- Adjustable by manually cranking winch.
- Great for areas with overhead obstructions or door height restrictions.
- Includes one rail with two trolleys and heavy-duty leveling jacks.
- OSHA compliant.*



8517709

Anchor height	Rail width	Wheels	# of Users	Part #
12.5 ft.-19 ft.	10 ft.	16 in. Pneumatic	2	8517701
12.5 ft.-19 ft.	20 ft.	16 in. Pneumatic	2	8517705
17.5 ft.-28.75 ft.	15 ft.	16 in. Pneumatic	2	8517707
17.5 ft.-28.75 ft.	20 ft.	16 in. Pneumatic	2	8517709
22.5 ft.-38.75 ft.	15 ft.	16 in. Pneumatic	2	8517711
22.5 ft.-38.75 ft.	20 ft.	16 in. Pneumatic	2	8517713

Accessory	Part #
Tow Bar	8518243

3M™ DBI-SALA® A-Frame System

- Provides a secure anchor point on portable structures.
- Can provide fall protection for two workers with the right configuration.
- Easily moved from one job site to the next.
- OSHA compliant.*



8517790

Fixed Height Systems

- Systems contain a single rail rated for two users.
- Great for areas with overhead obstructions or door height restrictions.
- Systems include heavy-duty leveling jacks.

Anchor height	Rail width	Wheels	# of Users	Part #
15 ft.	15 ft.	16 in. Caster	2	8517790
15 ft.	20 ft.	16 in. Caster	2	8517791
15 ft.	30 ft.	16 in. Caster	2	8517792
20 ft.	15 ft.	16 in. Caster	2	8517793
20 ft.	20 ft.	16 in. Caster	2	8517794
20 ft.	30 ft.	16 in. Caster	2	8517795
30 ft.	15 ft.	16 in. Caster	2	8517796
30 ft.	20 ft.	16 in. Caster	2	8517797
30 ft.	30 ft.	16 in. Caster	2	8517798

Adjustable Height Systems

- Adjust using an overhead crane, forklift or powered system.
- Great for areas with overhead obstructions and door height limitations.
- Systems include two rails for bypassing trolleys and heavy-duty leveling jacks.

Anchor height	Rail width	Wheels	# of Users	Part #
16 ft.-22.5 ft.	20 ft.	16 in. Pneumatic	2	8517780
16 ft.-22.5 ft.	30 ft.	16 in. Pneumatic	2	8517781

*Complies with requirements of OSHA 29 CFR 1910.140 and 1926.502.

3M™ DBI-SALA® Freestanding Ladder System

- Easy access fall protection for up to two users.
- Systems include guardrails and heavy-duty leveling jacks.
- Manual height adjustment via winch assembly.
- OSHA compliant.*

Platform height	System type	Wheels	# of Users	Part #
10.75 ft.-15.5 ft.	Portable ladder	16 in. Pneumatic	2	8517715
14.5 ft.-23 ft.	Portable ladder	16 in. Pneumatic	2	8517717
18.25 ft.-31 ft.	Portable ladder	16 in. Pneumatic	2	8517719

Accessory	Part #
Tow Bar	8518240



8517717 with 8518240 tow bar



3M™ DBI-SALA® Sky Anchor System

- Provides 360-degree mobility with 6 ft. safe working radius from anchor.
- Collapsible and lightweight aluminum design allows for easy setup.
- OSHA compliant.*

Anchor height	Offset	# of Users	Part #
15.25 ft.	6 ft.	1	8530152
18.75 ft.	6 ft.	1	8530161
21.25 ft.	6 ft.	1	8530387
23.25 ft.	7 ft.	1	8530320

Sky Anchor Base Configurations

- Each base option can be used with each Sky Anchor option.
- Base options are rated for one user.

Base image	Base type	Part #
	Top floor mount	8530210
	Core mount sleeve	8530314
	Flush floor mount	8530162**



8530152 with 8530210 base

*Complies with requirements of OSHA 29 CFR 1910.140 and 1926.502.

**Base Cap option can be used with this base.

3M™ DBI-SALA® Trailer Mounted Anchor System

- Provides a standalone solution, leveraging an integrated counterweight.
- Overhead anchorage points up to 21 ft. for two users.
- Quickly raises and lowers with integrated winch and handle.
- Includes heavy-duty stabilizing jacks.
- OSHA compliant.*
- System rated for off-road use only. Not allowed for use on highways or public roads.

Anchor height	Offset	# of Users	Part #
20.5 ft.	4 ft.	2	8530690

Accessory	Applies to	Part #
Drive Clutch Assembly	8530624, 8530690, 8530691	8548000
Job Box	8530690	8530678
Outrigger Pads	8530690, 8530691	8548050



8530690 (attachment not included)



8548000



8548050



8530678

*Complies with requirements of OSHA 29 CFR 1910.140 and 1926.502.



Fall Protection

The gear you need. The savings you want.

Trade-in or trade-up to get rebates on high-quality 3M™ DBI-SALA® and 3M™ Protecta® Fall Protection.

We're so confident you'll love our fall protection products, that we'll let you trade in your current gear and give you a rebate on new purchases. Harnesses, SRLs, lanyards and more—we're including over **1,200 products to choose from.**

If you already use 3M Fall Protection products, you can trade-up to get rebates on gear with more features and benefits.

It's a great time to assess your equipment and make the switch to 3M™ DBI-SALA® and 3M™ Protecta® Fall Protection.

Calculate your rebate at go.3M.com/FPtradein.



New 3M customers can Trade-in:



Trade in competitive fall protection products

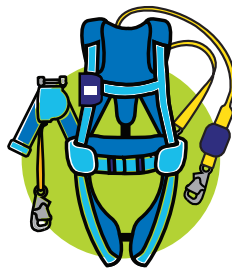

Purchase comparable qualifying* 3M Fall Protection products



Receive a cash rebate

Existing 3M customers can Trade-up:

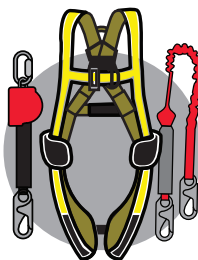

Trade in current 3M Fall Protection products

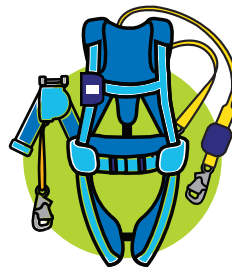

Purchase new, upgraded qualifying** 3M Fall Protection products



Receive a cash rebate

* Comparable qualifying products means anchor for anchor, harness for harness, etc. Except as noted in the Terms & Conditions.

** Upgraded qualifying products means current 3M customer must purchase a higher value comparable product to qualify for a rebate. (Example: Delta™ Harness traded in for an ExoFit NEX™ Harness. ExoFit NEX™ Harness for ExoFit™ STRATA™ Harness. 3M™ Protecta® SRL for 3M™ DBI-SALA® SRL.)

Offer subject to change without notice. Requires digital copy of your receipt of purchase from a 3M authorized distributor and digital images proving your old equipment was taken out of service (e.g. Harnesses with D-rings cut off, SRLs & Lanyards with hooks cut off). End users and/or distributors responsible for collecting and disposing of trade-in/trade-up products. Must follow requirements online to receive rebate. Distributors and wholesalers excluded. End user rebate only. Visit go.3M.com/FPtradein for full terms and conditions.

Full-Body Harnesses

Choose harness features:

1 Dorsal connection

The fall arrest attachment point located on the back, between the shoulders. Some allow for SRL attachment without pulling up the webbing or impeding use of the D-ring.



2 Webbing

Should be strong enough to endure rough use and exposure to weather without tearing or fraying. Specialty applications may require Nomex®/Kevlar® fibers or nylon that offers fire resistance or arc flash protection.

3 Adjusting points

Often found on legs, waist (belt models), chest and torso to allow a better fit. Some models may include revolving buckles that can be easily turned to help store and lock excess webbing in place.

4 Leg straps

Leg strap fasteners come in different styles, including tongue buckles, pass-through buckles and quick-connect buckles.



Tongue Buckle



Pass-Through Buckle



Quick-Connect Buckle

5 Pelvic support

Provides additional support, security and comfort, and can better distribute forces during a fall arrest event.

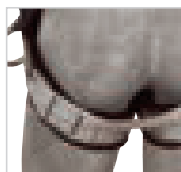

6 Padding

Cushioning relieves pressure to provide extra comfort, absorb energy and helps redistribute weight in a fall arrest event. May be removable or built-in to reduce slipping.

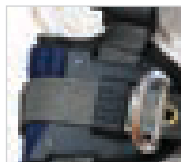

7 Seat slings

Removable and provides versatility and added comfort during long shifts.



8 Impact indicators

Provide immediate notice that the harness has been impact-loaded, simplifying inspection.



B Full-Body Harnesses

9 Lanyard keepers

Provide a place to park your lanyard when not in use, helping reduce tripping and entanglement hazards.



10 Lining

Some models feature breathable lining that wicks moisture away from your body to help keep you dry and comfortable.



11 Trauma straps

Easily deploy and hook together in seconds, allowing you to stand up while suspended in harness to relieve suspension trauma.



Next: Choose your model ▶

3M™ DBI-SALA® Full-Body Harnesses

Comfort. Productivity. Safety. No matter what you're looking for in a safety harness, we've got you covered with a full line of options and features to suit your style. Just find your size and climb with confidence.



1

2

3

ExoFit™ STRATA™ Premium, all-day comfort harness

- Patented design redistributes weight off wearer's shoulders.
- Lightweight aluminum D-rings.
- Easy-linking SRL adapter & standup D-ring simplify connections.
- Mesh padding enhances breathability and comfort.
- Revolving adjusters maintain fit and lock excess webbing in place.
- Quick-connecting buckles enhance productivity.
- 420 lb. capacity (Model shown #1112538).

ExoFit NEX™ Full-featured comfort fit harness

- Revolving adjusters maintain fit and lock excess webbing in place.
- Lightweight aluminum D-rings.
- Quick-connecting buckles enhance productivity.
- Non-slip, moisture-wicking padding.
- Water repellent coating resists mold and dirt.
- Standup dorsal D-ring simplifies connections.
- 420 lb. capacity (Model shown #1113130).

ExoFit NEX™ Arc Flash Comfortable, ASTM F887 compliant harness

- Flame-resistant Nomex®/Kevlar® webbing rated to 7,000 lbs.
- Revolving adjusters maintain fit and lock excess webbing in place.
- Conductive-resistant, PVC-coated aluminum D-rings.
- Leather insulators help prevent contact between hardware and body.
- Comfortable, lightweight arc flash-rated padding.
- Quick-connecting buckles enhance productivity.
- 420 lb. capacity (Model shown #1113318).

Select your work:

Construction	1	2	3	4	5	6
Tower Climbing	1	2	3	4	5	6
Vest	1	2		4	5	6
Crossover		2		4		6
Wind Energy		2		4		
Mining		2				
Iron Work				4		6

Oil & Gas		2		4		6
Rope Access/Rescue		2	3			
Lineman			3			
Positioning			3		5	
Scaffolding					5	
Arc Flash/Hot Work Use		2	3			6



4

ExoFit™
Original comfort fit harness

- Ultra-soft edging resists chafing.
- Easily-adjustable torso buckles.
- Quick-connect buckles allow for one-handed donning.
- Cushioned pads designed to resist slipping off shoulders.
- Ballistic nylon construction resists abrasion.
- 420 lb. capacity (Model shown #1107981).



5

Delta™ Comfort
Entry-level comfort harness

- Revolving adjusters maintain fit and lock excess webbing in place.
- Vented shoulder, back and leg padding helps keep wearer cool.
- Sewn-in dorsal pad holds personal SRLs and helps eliminate slippage.
- Visual indicators alert wearer if harness has been impact-loaded.
- Rigid tool belt allows for up to 60 lbs. of tools.
- Tongue buckle legs simplify adjustment.
- 420 lb. capacity (Model shown #1100798).



6

Delta™
Entry-level harness

- Revolving adjusters maintain fit and lock excess webbing in place.
- Tangle-free design falls into place when donned.
- Ergonomic hip pad supports back and hips.
- Quick-connect buckles enhance productivity.
- Water repellent coating resists mold and dirt.
- Standup dorsal D-ring simplifies connections.
- 420 lb. capacity (Model shown #1110575).

Select your size:

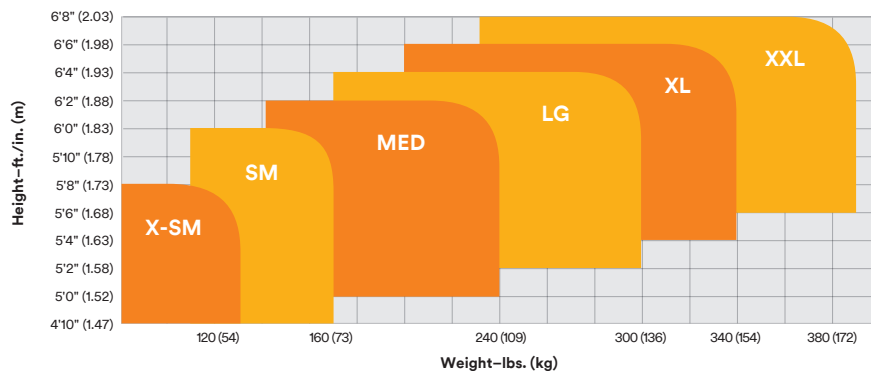

3M™ DBI-SALA® ExoFit™ STRATA™ Full-Body Harnesses

Lighten up with the first harness to feature an innovative load distribution system that literally takes the weight off your shoulders.

- Patented design redistributes weight off wearer's shoulders.
- Lightweight aluminum D-rings.
- Easy-linking SRL adapter & standup D-ring simplify connections.
- Mesh padding enhances breathability and comfort.
- Revolving adjusters maintain fit and lock excess webbing in place.
- 420 lb. capacity (Model shown #1112538).
- Quick-connecting buckles enhance productivity.

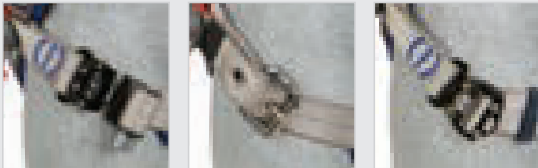

Triple Action Buckle Tongue Buckle Quick Connect Buckle

3M™ DBI-SALA® ExoFit™ STRATA™ Tower-Climbing Harnesses

These harnesses feature a special removable seat sling used for tower work.

Selection guide:

Chest Buckle	Leg Buckles	D-rings (Back, Hips, Chest, Shoulder)	Small	Medium	Large	XLarge
Triple Action	Triple Action	1B, 1C	1112580	1112581	1112582	1112583
Triple Action	Tongue Buckle	1B, 1C, 2H	1112585	1112586	1112587	1112588

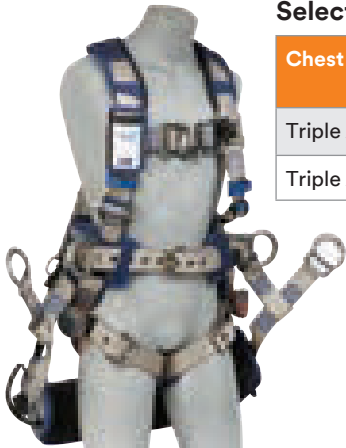

1112588

3M™ DBI-SALA® ExoFit™ STRATA™

Construction-Style Harnesses



1112538

Selection guide:

Chest Buckle	Leg Buckles	D-rings (Back, Hips, Chest, Shoulder)	Small	Medium	Large	XLarge
Quick Connect	Quick Connect	1B, 2H	1112500	1112501	1112502	1112503
Triple Action	Triple Action	1B, 2H	1112535	1112536	1112537	1112538
Triple Action	Triple Action	1B, 1C, 2H	1112540	1112541	1112542	1112543
Triple Action	Triple Action	1B, 1C, 2H, 2S	1112545	1112546	1112547	1112548
Quick Connect	Quick Connect	1B, 2H	1112550	1112551	1112552	1112553
Quick Connect	Quick Connect	1B, 1C	1112555	1112556	1112557	1112558
Quick Connect	Quick Connect	1B, 1C, 2H, 2S	1112560	1112561	1112562	1112563
Triple Action	Tongue Buckle	1B, 2H	1112565	1112566	1112567	1112568
Triple Action	Tongue Buckle	1B, 1C	1112570	1112571	1112572	1112573
Triple Action	Tongue Buckle	1B, 1C, 2H, 2S	1112575	1112576	1112577	1112578
Triple Action	Triple Action	1B	1112665	1112666	1112667	1112668
Triple Action	Tongue Buckle	1B	1112670	1112671	1112672	1112673
Triple Action	Triple Action	1B, 1C, 2H	1112679	1112675	1112676	1112677
Triple Action	Triple Action	1B, 1C, 2H	1114082	1114083	1114084	1114085

3M™ DBI-SALA® ExoFit™ STRATA™

Vest-Style Harnesses

These harnesses include the same great features of the ExoFit™ STRATA™ without the integrated load distribution system.



1112483

Selection guide:

Chest Buckle	Leg Buckles	D-rings (Back, Hips, Chest, Shoulder)	Small	Medium	Large	XLarge
Triple Action	Triple Action	1B	1112475	1112476	1112477	1112478
Triple Action	Triple Action	1B, 2H	1112480	1112481	1112482	1112483
Triple Action	Triple Action	1B, 1C	1112485	1112486	1112487	1112488
Triple Action	Triple Action	1B, 1C, 2H	1112490	1112491	1112492	1112493
Quick Connect	Quick Connect	1B	1112495	1112496	1112497	1112498
Quick Connect	Quick Connect	1B, 1C	1112505	1112506	1112507	1112508
Quick Connect	Quick Connect	1B, 1C, 2H	1112510	1112511	1112512	1112513
Triple Action	Tongue Buckle	1B	1112515	1112516	1112517	1112518
Triple Action	Tongue Buckle	1B, 2H	1112520	1112521	1112522	1112523
Triple Action	Tongue Buckle	1B, 1C	1112525	1112526	1112527	1112528
Triple Action	Tongue Buckle	1B, 1C, 2H	1112530	1112531	1112532	1112533
Triple Action	Tongue Action	1B, 1C, 2H, 2S	1114086	1114087	1114088	1114089

3M™ DBI-SALA® ExoFit NEX™ Full-Body Harnesses

Comfortable and lightweight. Functional and durable. These harnesses are engineered to perform and built to last.

- Revolving adjusters maintain fit and lock excess webbing in place.
- Non-slip, moisture-wicking padding and soft edging.
- Lightweight aluminum D-rings.
- Integrated trauma straps to minimize suspension trauma.
- Quick-connecting buckles enhance productivity.
- Water repellent coating resists mold and dirt.
- Reflective material enhances visibility in the dark.
- Built-in carrying pocket for phones or radios.
- Standup dorsal D-ring simplifies connections.
- 420 lb. capacity (Model shown #1113130).



3M™ DBI-SALA® ExoFit NEX™ Vest-Style Full-Body Harnesses

Vest-Style Harnesses are the most universal, with multiple configurations and connection point options. They're used across a wide variety of industries.

Selection guide:

Chest Buckle	Leg Buckles	D-rings (Back, Hips, Chest, Shoulder)	Small	Medium	Large	XLarge
Quick Connect	Quick Connect	1B	1113001	1113004	1113007	1113010
Quick Connect	Quick Connect	1B, 1C	1113031	1113034	1113037	1113040
Quick Connect	Quick Connect	1B, 1C, 2H	1113046	1113049	1113052	1113055
Quick Connect	Quick Connect	1B, 2S	1113061	1113064	1113067	1113070
Quick Connect	Quick Connect	1B, 1C, 2H	1113076	1113079	1113082	1113085



1113085

3M™ DBI-SALA® ExoFit NEX™ Crossover-Style Harnesses

A front-mounted D-ring makes the crossover-style a great choice for a rescue harness and for ladder climbing applications.

Selection guide:

Chest Buckle	Leg Buckles	D-rings (Back, Hips, Chest, Shoulder)	Small	Medium	Large	XLarge
Quick Connect	Quick Connect	1B, 1C	1113091	1113094	1113097	1113100
Quick Connect	Quick Connect	1B, 1C, 2H	1113106	1113109	1113112	1113115



1113115

3M™ DBI-SALA® ExoFit NEX™

Tower-Climbing Harnesses

Tower climbing models are built to keep workers comfortable during extended hours in harness. Tool loops are used for carrying equipment and the removable seat sling adds more comfort for all-day use.

Selection guide:

Chest Buckle	Leg Buckles	D-rings (Back, Hips, Chest, Shoulder)	Small	Medium	Large	XLarge
Quick Connect	Quick Connect	1B, 1C, 2H	1113190	1113191	1113192	1113193



1113193

3M™ DBI-SALA® ExoFit NEX™

Construction-Style Harnesses

Made for general construction work, these harnesses have excellent tool-carrying capability, a sewn-in protective hip pad to prevent sagging and a removable tongue buckle body belt.

Selection guide:

Chest Buckle	Leg Buckles	D-rings (Back, Hips, Chest, Shoulder)	Small	Medium	Large	XLarge
Quick Connect	Quick Connect	1B, 2H	1113121	1113124	1113127	1113130
Quick Connect	Quick Connect	1B, 2H	1113151	1113154	1113157	1113160
Quick Connect	Tongue Buckle	1B, 2H	1113136	1113139	1113142	1113145



1113130

3M™ DBI-SALA® ExoFit NEX™

Global Wind Energy Harnesses

Meets major global compliance standards including ANSI, OSHA, CSA and CE. Convenient features include a radio/phone holster, sewn-in hip pad with belt and an optional, replaceable lumbar protector (*starred products only).

Selection guide:

Chest Buckle	Leg Buckles	D-rings (Back, Hips, Chest, Shoulder)	Small	Medium	Large	XLarge
Quick Connect	Quick Connect	1B, 1C, 2H	1113215*	1113216*	1113217*	1113218*
Quick Connect	Quick Connect	1B, 1C, 2H	1113210	1113211	1113212	1113213



1113218

3M™ DBI-SALA® ExoFit NEX™

Mining Vest-Style Harnesses

Features integrated hip padding and equipment straps that allow for convenient carrying of equipment that miners need to get the job done.

Selection guide:

Chest Buckle	Leg Buckles	D-rings (Back, Hips, Chest, Shoulder)	Small	Medium	Large	XLarge
Quick Connect	Quick Connect	1B	1113195	1113196	1113197	1113199



1113199

3M™ DBI-SALA® ExoFit NEX™

Oil & Gas Full-Body Harnesses

Developed specifically for the needs of the on-shore and off-shore drilling markets, including seat slings, an 18 in. D-ring extension and derrick attachments.



1113298

Selection guide:

Chest Buckle	Leg Buckles	D-rings (Back, Hips, Chest, Shoulder)	Small	Medium	Large	XLarge
Quick Connect	Tongue Buckle	1B, 1C, 2H	1113295	1113296	1113297	1113298
Quick Connect	Tongue Buckle	1B, 1C, 2H	1113290	1113291	1113292	1113293
Pass-Through	Tongue Buckle	1B, 1C, 2H	1113305	1113306	1113307	1113308
Quick Connect	Tongue Buckle	1B, 2H	1113285	1113286	1113287	1113288

3M™ DBI-SALA®

Derrick Belt



1003222

Selection guide:

Attachment	Small	Medium	Large	XLarge	Use with Harness
Tongue Buckle	1003230	1003220	1003221	1003222	1113298 or 1113288
Pass-Through	1000572	1000573	1000570		1113293

3M™ DBI-SALA® ExoFit NEX™

Rope Access & Rescue Harnesses

Specially designed multi-use harnesses with hybrid comfort padding, optimized for rope rescue and industrial rope access work. Used for rescue/emergency services, industrial rope access and rigging, wind energy and tower maintenance, or arborist activities.



1113348

Selection guide:

Chest Buckle	Leg Buckles	D-rings (Back, Hips, Chest, Shoulder)	Small	Medium	Large	XLarge
Quick Connect	Quick Connect	1B, 1C, 2H	1113345	1113346	1113347	1113348
Quick Connect	Quick Connect	1B, 1C, 2H	1113370	1113371	1113372	1113373

3M™ DBI-SALA® ExoFit NEX™ Arc Flash Full-Body Harnesses

All the comfort, function and durability you expect, paired with the flame resistance and conductive-resistant construction needed for high voltage electricity or hot-work, like welding. Meets arc flash standard specifications for personal climbing equipment as well as ANSI Z359 and CSA requirements.

- Flame-resistant Nomex®/Kevlar® webbing rated to 7,000 lbs.
- Revolving adjusters maintain fit and lock excess webbing in place.
- Flame-resistant trauma straps.
- Conductive-resistant, PVC-coated aluminum D-rings.
- Leather insulators help prevent contact between hardware and body.
- Comfortable, lightweight arc flash-rated padding and soft edging.
- Quick-connecting buckles enhance productivity.
- Tested to perform to ASTM F887 for personal climbing equipment.
- 420 lb. capacity (Model shown 1113318).



3M™ DBI-SALA® ExoFit NEX™ Arc Flash Vest-Style Full-Body Harnesses

These harnesses feature Nomex®/Kevlar® fiber webbing, PVC coated D-rings and comfort padding.



1113493

Selection guide:

Harness Type	Chest Buckle	Leg Buckles	D-rings (Back, Hips, Chest, Shoulder)	Small	Medium	Large	XLarge
Standard	Quick Connect	Quick Connect	1B	1103085	1103086	1103087	1103088
Standard	Pass-Through	Pass-Through	1B	1113335	1113336	1113337	1113338
Positioning	Quick Connect	Quick Connect	1B, 2H	1103070	1103071	1103072	1103073
Rescue	Quick Connect	Quick Connect	1B Loop, 2C Loops	1113325	1113326	1113327	1113328
Climbing	Quick Connect	Quick Connect	1B, 1C, 2H	1113330	1113331	1113332	1113333
Construction	Quick Connect	Quick Connect	1B, 1C, 2H	1113490	1113492	1113491	1113493

3M™ DBI-SALA® ExoFit NEX™ Arc Flash

Construction-Style Harnesses

With an integrated hip pad and body belt, these harnesses have excellent tool-carrying capabilities, allow work positioning and provide added back support.



1113369

Selection guide:

Harness Type	Chest Buckle	Leg Buckles	D-rings (Back, Hips, Chest, Shoulder)	Small	Medium	Large	XLarge
Construction	Quick Connect	Quick Connect	1B, 2H	1113315	1113316	1113317	1113318
Tower Climbing AFK	Quick Connect	Quick Connect	1B Loop, 1C, 2H, Seat Sl ing	1113357	1113358	1113368	1113369

3M™ DBI-SALA® ExoFit NEX™ Arc Flash

Full-Body Harnesses



1113692

Selection guide:

Harness Type	Chest Buckle	Leg Buckles	D-rings (Back, Hips, Chest, Shoulder)	Small	Medium	Large	XLarge
Rope Access/ Rescue	Quick Connect	Quick Connect	1B, 2H	1113761	1113762	1113763	1113764
Rope Access/ Rescue	Quick Connect	Quick Connect	1B, 2H	1113768	1113774	1113781	1113786
Rope Access/ Rescue	Quick Connect	Quick Connect	1B, 2H	1113757	1113758	1113759	1113760
Lineman with 2D Belt	Quick Connect	Quick Connect	1B, 2H	1113676	1113682	1113688	1113692



1113760



1113764



1113786

For Lineman Belts and Harnesses, see page 62.

3M™ DBI-SALA® ExoFit™ Full-Body Harnesses

Simple and comfortable. These harnesses feature a single piece of material that wraps around you in the shape of an X to reduce tangling and provide additional security.

- Soft edging resists chafing.
- Easily-adjustable torso buckles.
- Quick-connect buckles allow for one-handed donning.
- Cushioned pads designed to resist slipping off shoulders.
- Breathable lining helps keep you comfortably dry.
- Ballistic nylon construction resists abrasion.
- Reflective piping enhances visibility in low lighting.
- Back D-ring rated to 5,000 lb. minimum tensile strength.
- 420 lb. capacity (Model shown #1107981).



3M™ DBI-SALA® ExoFit™ Vest-Style Harnesses

Vest-style harnesses are the most universal, with multiple configurations and connection point options. They're used across a wide variety of industries.

Selection guide:

Chest Buckle	Leg Buckles	D-rings (Back, Hips, Chest, Shoulder)	Small	Medium	Large	XLarge
Quick Connect	Quick Connect	1B	1107975	1107976	1107977	1107981
Quick Connect	Quick Connect	1B, 1C	1108525	1108526	1108527	1108532
Quick Connect	Quick Connect	1B, 2H	1108575	1108576	1108577	1108581
Quick Connect	Quick Connect	1B, 1C, 2H	1108600	1108601	1108602	1108606
Quick Connect	Tongue Buckle	1B	1109356	1109355	1109357	1109358



1108606

3M™ DBI-SALA® ExoFit™
Crossover-Style Harnesses

A front-mounted D-ring makes the crossover-style a great choice for ladder climbing and rescue applications.



1108706

Selection guide:

Chest Buckle	Leg Buckles	D-rings (Back, Hips, Chest, Shoulder)	Small	Medium	Large	XLarge
Quick Connect	Quick Connect	1B, 1C	1108675	1108676	1108677	1108682
Quick Connect	Quick Connect	1B, 1C, 2H	1108700	1108701	1108702	1108706

3M™ DBI-SALA® ExoFit™
Construction-Style Positioning Harnesses

Made for general construction work, these harnesses have excellent tool-carrying capability, a sewn-in hip pad and removable body belt.



1108519

Selection guide:

Chest Buckle	Leg Buckles	D-rings (Back, Hips, Chest, Shoulder)	Small	Medium	Large	XLarge
Quick Connect	Quick Connect	1B, 1C	1108977	1108978	1108975	1108979
Quick Connect	Quick Connect	1B, 2H	1108500	1108501	1108502	1108507
Quick Connect	Tongue Buckle	1B, 2H	1110475	1110476	1110477	1110478
Quick Connect	Quick Connect	1B, 2H	1108516	1108517	1108518	1108519

3M™ DBI-SALA® ExoFit™
Derrick Harnesses

Comfortable and easy to don for monkey and tubing board operators. Includes connections for an optional derrick belt (1000570) to enhance comfort while positioning for the next drilling pipe. Vest style, 18 in. D-ring extension.



1100303

Selection guide:

Shoulder Buckles	Chest Buckle	Leg Buckles	D-rings (Back, Hips, Chest, Shoulder)	Small	Medium	Large	XLarge
Pass-Through	Quick Connect	Tongue Buckle	2B	1100300	1100301	1100302	1100303

3M™ DBI-SALA® ExoFit™
Wind Energy Harnesses

Our wind industry harnesses meet the major global compliance standards including ANSI, OSHA, CSA and CE. Includes reinforced lumbar area for added back support and integrated trauma straps.



11108657

Selection guide:

Harness Type	Chest Buckle	Leg Buckles	D-rings (Back, Hips, Chest, Shoulder)	Small	Medium	Large	XLarge
Wind Energy	Quick Connect	Quick Connect	1B, 1C, 2H	1102385	1102386	1102387	1102388
Wind Energy	Quick Connect	Quick Connect	1B, 1C, 2H	1102340	1102341	1102342	1102343
Tower Climbing	Quick Connect	Quick Connect	1B, 1C, 2H	1108650	1108651	1108652	1108657
Iron Worker's	Quick Connect	Tongue Buckle	1B, 2H	1100530	1100531	1100532	1100533

3M™ DBI-SALA® Delta™ Comfort Full-Body Harnesses

Combines innovative technologies with popular features, making them the workhorse of the industry.

- Revolving adjusters maintain fit and lock excess webbing in place.
- Vented shoulder, back and leg padding helps keep wearer cool.
- Sewn-in dorsal pad holds personal SRLs and helps eliminate slippage.
- Visual indicators alert wearer if harness has been impact-loaded.
- Rigid tool belt allows for up to 60 lbs. of tools.
- Tongue buckle legs simplify adjustment.
- Equipped with 3M™ Connected Safety RFID tag.
- 420 lb. capacity (Model shown #1100798).



3M™ DBI-SALA® Delta™ Comfort Full-Body Harnesses



1100798

Selection guide:

Harness Type	Chest Buckle	Leg Buckles	D-rings (Back, Hips, Chest, Shoulder)	Small	Medium	Large	XLarge
Vest-Style Climbing	Quick Connect	Quick Connect	1B, 1C	1100636	1100637	1100638	1100639
Vest-Style	Quick Connect	Tongue Buckle	1B	1100745	1100746	1100747	1100748
Construction-Style Positioning	Quick Connect	Tongue Buckle	1B, 2H	1100795	1100796	1100797	1100798
Vest-Style Positioning	Quick Connect	Quick Connect	1B, 2H	1100821	1100822	1100823	1100824
Construction-Style Positioning/ Climbing	Quick Connect	Quick Connect	1B, 1C, 2H	1100517	1100518	1100519	1100523
Construction-Style Positioning	Quick Connect	Quick Connect	1B, 2H	1100785	1100786	1100787	1100788
Vest-Style	Quick Connect	Quick Connect	1B	1100935	1100936	1100937	1100938
Scaffolding	Quick Connect	Quick Connect	1B	1100945	1100946	1100947	1100948

3M™ DBI-SALA® Delta™ Full-Body Harnesses

Tough and versatile. These harnesses include popular features and support your back and hips while bearing heavy loads to maximize your comfort.

- Revolving adjusters maintain fit and lock excess webbing in place.
- Tangle-free design falls into place when donned.
- Ergonomic hip pad supports back and hips.
- Quick-connect buckles enhance productivity.
- Water repellent coating resists mold and dirt.
- Impact indicator simplifies safety inspections.
- Lanyard keepers help reduce trip hazards.
- Standup dorsal D-ring simplifies connections.
- Arc flash-rated models available.
- 420 lb. capacity (Model shown #1110575).



3M™ DBI-SALA® Delta™ Vest-Style Harnesses

Vest-style harnesses are widely used, with multiple configurations and connection point options. They're used across a wide variety of industries.

Selection guide:



1102008

Chest Buckle	Leg Buckles	D-rings (Back, Hips, Chest, Shoulder)	Universal Size
Pass-Through	Pass-Through	1B, 2S	1101781
Pass-Through	Tongue Buckle	1B, 2S	1101254
Quick Connect	Quick Connect	1B, 2S	1110602
Pass-Through	Tongue Buckle	1B	1102000
Quick Connect	Quick Connect	1B	1110600
Pass-Through	Pass-Through	1B	1103321
Pass-Through	Tongue Buckle	1B, 2H	1102008
Quick Connect	Quick Connect	1B, 2H	1110625
Pass-Through	Pass-Through	1B, 2H	1103875
Quick Connect	Quick Connect	1B, 1C	1102090
Pass-Through	Tongue Buckle	1B, 1C	1107807
Pass-Through	Pass-Through	1B, 1C	1112126
Pass-Through	Parachute Buckle	1B	1102001
Quick Connect	Pass-Through	1B, Conductive-resistant hardware	1104725

3M™ DBI-SALA® Delta™ Construction-Style Harnesses

Made for general construction work, these harnesses have excellent tool-carrying capability, a sewn-in hip pad and removable body belt.



1101656

Selection guide:

Chest Buckle	Leg Buckles	D-rings (Back, Hips, Chest, Shoulder)	Small	Medium	Large	XLarge
Quick Connect	Quick Connect	1B, 2H	1110575	1110576	1110577	1110578
Pass-Through	Tongue Buckle	1B, 2H	1102201	1101654	1101655	1101656
Pass-Through	Tongue Buckle	1B, 1C, 2H	1107805	1107802	1107801	1107809

Chest Buckle	Leg Buckles	D-rings (Back, Hips, Chest, Shoulder)	Universal Size
Pass-Through	Pass-Through	1B, 2H	1103512
Pass-Through	Tongue Buckle	1B, 2H	1103525
Pass-Through	Pass-Through	1B	1103513
Pass-Through	Tongue Buckle	1B, loops for belt	1102025

3M™ DBI-SALA® Delta™ Crossover-Style Harnesses

A front-mounted D-ring makes the crossover-style a great choice for ladder climbing and rescue applications.



110725

Selection guide:

Leg Buckles	D-rings (Back, Hips, Chest, Shoulder)	Small	Medium	Large	XLarge
Pass-Through	1B, 1C	1101809	1101810	1101811	1101812

Leg Buckles	D-rings (Back, Hips, Chest, Shoulder)	Universal Size
Tongue Buckle	1B, 1C	1102950
Quick Connect	1B, 1C	1110700
Pass-Through	1B, 1C	1102010
Tongue Buckle	1B, 1C, 2H	1103375
Quick Connect	1B, 1C, 2H	1110725
Pass-Through	1B, 1C, 2H	1103270

3M™ DBI-SALA® Delta™ Full-Body Harnesses



1103352

Selection guide:

Harness Type	Chest Buckle	Leg Buckles	D-rings (Back, Hips, Chest, Shoulder)	Small	Medium	Large	XLarge
Iron Worker's Vest	Pass-Through	Pass-Through	1B	1106453	1106451	1106450	1106452
Iron Worker's Vest	Pass-Through	Tongue Buckle	1B, 2H	1106403	1106404	1106405	1106408
Tower Climbing Vest	Pass-Through	Tongue Buckle	1B, 1C, 2H	1107776	1107777	1107775	1107778
Tower Climbing Crossover	N/A	Tongue Buckle	1C, 2H	1103355	1103351	1103350	1103352

3M™ DBI-SALA® Delta™

Arc Flash Harnesses

Tested to perform in accordance with the stringent ASTM F887 Standard Specification for Personal Climbing Equipment. Features 7,000 lb. nylon web and leather insulators.

Selection guide:



1110782

Chest Buckle	Leg Buckles	Web Loop (Back, Front)	Small	Medium	Large	XLarge
N/A	Pass-Through	1B, 1F	1110754	1110750	1110751	1110752
Quick Connect	Quick Connect	1B, 2F	1110788	1110780	1110781	1110782
Quick Connect	Tongue Buckle	1B, 2F	1110773	1110774	1110783	1100784

Harness Type	Chest Buckle	Leg Buckles	D-rings (Back, Hips, Chest)	Universal Size
Standard	Pass-Through	Pass-Through	1B	1110830
Vest	Quick Connect	Quick Connect	Back Loop	1110820
Crossover	Pass-Through	Pass-Through	1B, 1C, 2H	1110940

1150058

3M™ DBI-SALA® Delta™ Arc Flash Kit

Includes 1110752 Delta Arc Flash Nylon Harness with web loop and Arc Flash Shock-Absorbing Lanyard, 6 ft. (1246305), with bag. (XLarge)

1150054 Kit with Large harness (1110752)



3M™ DBI-SALA® Delta™

Harnesses for Hot Work Use

With heat-resistant and flame-retardant Nomex®/Kevlar® fiber webbing, these harnesses have a 700° Fahrenheit char temperature. 310 lbs. (140 Kg) capacity.

Selection guide:



1104775

Harness Type	Chest Buckle	Leg Buckles	D-rings (Back, Hips, Chest, Shoulder)	Universal Size
Vest	Pass-Through	Pass-Through	1B	1105475
Crossover	N/A	Pass-Through	1B, 1C, 2H	1104775
Vest	Pass-Through	Pass-Through	1B	1104625
Vest	Quick Connect	Quick Connect	1B	1109975

3M™ DBI-SALA® Delta Vest™ Hi-Vis Work Vest Harnesses

Our sleeveless waist-length vests feature a built-in harness for high visibility while working at-height, day or night. They meet ANSI class II requirements for high visibility vests.



1111580

Selection guide:

Style	Leg Buckles	D-rings (Back)	Universal Size
Orange Reflective	Quick Connect	1B	1111580
Yellow Reflective	Quick Connect	1B	1111584
Blue Non-Reflective	Quick Connect	1B	1115676
Hi-Vis Orange Reflective	Tongue Buckle	1B	1107404
Hi-Vis Yellow Reflective	Tongue Buckle	1B	1107420
Blue Non-Reflective	Tongue Buckle	1B	1107416

3M™ DBI-SALA® Delta Vest™ Oil and Derrick Harnesses

Designed for easy donning and use by workers who operate the monkey and tubing boards on oil rigs. They also include connections for an optional derrick belt, which adds comfort while positioning for the next drilling pipe.



1106107

Selection guide:

Chest Buckle	Leg Buckles	D-rings (Back, Hips, Chest, Shoulder, Lifting)	Small	Medium	Large	XLarge
Pass-Through	Tongue Buckle	1B, 2L	1105826	1105827	1105825	1105828
Pass-Through	Tongue Buckle	1B	1106112	1106108	1106106	1106107
Pass-Through	Tongue Buckle	1B, 2L	1106357	1106350	1106353	1106354

3M™ DBI-SALA® Delta Vest™ Derrick Belts



1000545

Selection guide:

Connection Buckle	D-rings	Small	Medium	Large	XLarge	Universal
Pass-Through	2	1000542	1000543	1000544	1000545	
Pass-Through	2					1000570
Tongue Buckle	2	1003230	1003220	1003221	1003222	

3M™ DBI-SALA® Delta™ Resist Webbing Harness

Helps protect against grease, oil, dirt and grime with integrated Resist Technology (polyurethane coated webbing).



1110990

Selection guide:

Harness Type	Chest Buckle	Leg Buckles	D-rings (Back)	Universal
Vest	Pass-Through	Tongue Buckle	1B	1110990

Lineman Belts and Harnesses

3M™ DBI-SALA® 4D Lineman Belts

Innovative design keeps the center of gravity at the top of the belt for improved safety and optimal comfort.

- 1 Durable 100% top-grain leather
- 2 Hassle-free connections to S-shaped, full floating D-rings
- 3 3M™ DBI-SALA® Cynch-Lok™ Fall-Restricting Device compatible (see page 82)
- 4 Comfortable, innovative design distributes weight throughout the contoured, reinforced seat
- 5 Easy adjustments with durable grommet tongue buckle belt



3M™ DBI-SALA® 2D Lineman Belts

Easily-adjustable belt with grommet tongue buckle, made in Red Wing, MN with 100% top grain leather.



ExoFit NEX™ Arc Flash Harness with 2D Belt				
Small	1113675 – D20	1113676 – D21	1113677 – D22	1113678 – D23
Medium	1113681 – D22	1113682 – D23	1113683 – D24	1113684 – D25
Large	1113688 – D25	1113689 – D26	1113690 – D27	–
XLarge	1113691 – D25	1113692 – D26	1113693 – D27	–



Where to measure to determine the correct “D” size for a Lineman’s Belt:

X = Distance from waist or top of hip bone to where Lineman’s Belt is worn.

Y = Measurement is from front of hip bone around the back to the front of the other hip bone. This measurement is the “D” size.



2D Belt		4D Belt	
D Size	SKU	D Size	SKU
D18	1001379	D18	1001392
D19	1001380	D19	1001393
D20	1001381	D20	1001394
D21	1001382	D21	1001395
D22	1001383	D22	1001396
D24	1001385	D23	1001397
D25	1001386	D24	1001398
D26	1001387	D25	1001399
D27	1001388	D26	1001400
D28	1001389	D27	1001401
D29	1001390	D28	1001402
D30	1001391	D29	1001403
		D30	1001404

D Size (in.)	Belt Sizing (in.)		
	Minimum	Center Hole	Maximum
D18	32	36	40
D19	33	37	41
D20	34	38	42
D21	36	40	44
D22	37	41	45
D23	38	42	46
D24	40	44	48
D25	41	45	49
D26	42	46	50
D27	44	48	52
D28	45	49	53
D29	46	50	54
D30	47	51	55

Belts, Workseats & Accessories

3M™ DBI-SALA® Workseats

1001190

Bosun Chair

12 in. x 24 in. x 1 in. board, cushion and side snaps.



1001140

Bosun Chair only

12 in. x 24 in. x 1 in. board.



1001378

Suspended Workman's Chair

Polyester webbing, alloy steel connectors, weight capacity of up to 420 lbs.



3M™ DBI-SALA® Tongue Buckle Belts



Selection guide:

D-rings	Pad	Small	Medium	Large	XLarge
2 (Side)	3 in. (7.6 cm)	1000022	1000023	1000024	1000025
None	No Pad	1000052	1000053	1000054	1000055
1 (Back)	3 in. (7.6 cm)	1000002	1000003	1000004	1000005
None	No Pad, ExoFit™	1000708	1000709	1000716	1000717

3M™ DBI-SALA® Suspension Trauma Safety Straps

Relieve downward pressure after a fall with these easy-to-deploy safety straps (compatible with most harness brands).

9501403

Safety Straps, One Pair.

9505712

Flame-Resistant Safety Straps, One Pair.

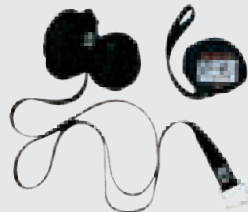

9511597

Harness and Lanyard Bag

3M™ DBI-SALA® Bag 7-1/2 in. wide x 6-1/2 in. deep x 15-1/2 in. long, holds a harness and lanyard or 50 ft. of 5/8 in. rope.

9511597 Small

9503806 Medium



9500468

Offshore Life-Jacket

Offshore Orange Life-Vest, back opening for harness, safety whistle, 62 sq. in. of SOLAS (Safety of Life at Sea) grade reflective tape, foam-filled head support collar with two vertical adjustable straps, hinged back panel for comfort. Cat. No: 1600 type 1-US Coast Guard Approved. (Universal size)



1231117

D-ring Extension

D-ring at one end, snap hook at other x 18 in. (46 cm).



11501443

Auto-Resetting Lanyard Keeper - Qty. 2

Breakaway lanyard keepers automatically reset and can be positioned along the chest area of your harness webbing.

1150444 Lanyard Keeper - Qty. 50

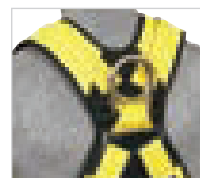

9501207

3M™ DBI-SALA® Delta™ Comfort Pad

Attaches to most harnesses to provide wrap-around comfort.

OSHA Final Rule on Walking-Working Surfaces

This new rule applies to all general industry workplaces, covering surfaces like floors, stairs, ladders, scaffolds and elevated walkways. The goal is to reduce slips, trips and falls across several industries. This rule increases consistency between the general industry and construction standards. Compliance dates vary, to give businesses time to understand the changes and upgrade their equipment. See our Technical Bulletin or contact customer service for more information.

OSHA 29 CFR 1910

If workers use personal fall protection or work in other high hazard situations, they must be trained and retrained in a manner they understand.



KEY CHANGE:

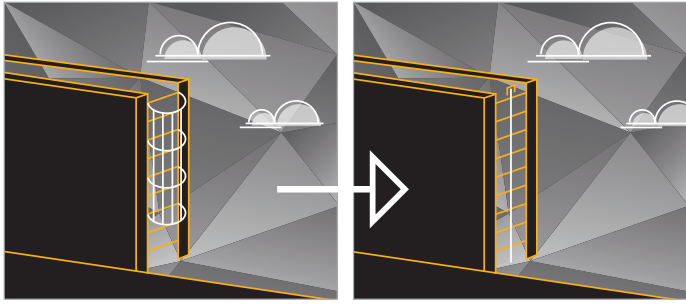

Fixed ladder cages and wells will be phased out and replaced with ladder safety systems or personal fall arrest systems.

KEY CHANGE:

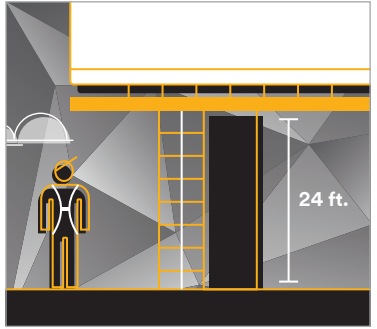

Outdoor advertising qualified climbers will need fall protection and fixed ladders over 24 ft. will require a ladder safety system.

KEY CHANGE:

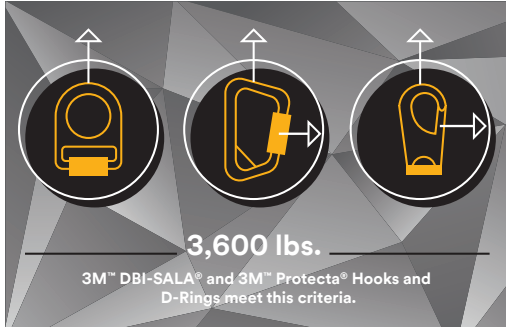

Fall protection D-rings, carabiners and snap hooks must be proof tested for tensile loads of 3,600 lbs. And gate strengths must also be designed to withstand at 3,600 lbs.

Learn more about this and other safety standard updates at [3M.com/FallProtection](https://www.3m.com/FallProtection).

3M™ DBI-SALA® Self-Retracting Lifelines



C Self-Retracting Lifelines

3M™ DBI-SALA® Nano-Lok™ Self-Retracting Lifelines

The Nano-Lok SRL is ergonomically designed for ease-of-use and direct connection to most harnesses. It locks quickly, stopping a fall after a matter of inches, providing more protection at low fall clearance heights.

- Twin-leg anchorage connector lets workers attach two SRLs directly to the back of most harnesses.
- Centrifugal brakes stop falling workers after a matter of inches.
- Impact-resistant housing helps provide maximum durability.
- RFID equipped to help track equipment and manage safety inspection programs.

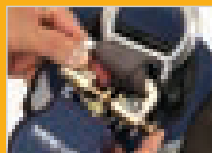

Direct-to-harness connection

Single-leg or twin-leg connectors install underneath the webbing on most harnesses, leaving the D-ring open for other equipment or rescue.

3M™ DBI-SALA® Nano-Lok™ Single-Leg Self-Retracting Lifelines

3101215

Nano-Lok Self-Retracting Lifeline

With Steel Snap Hook and Steel Carabiner x 6 ft. (1.8 m)



3101225

Nano-Lok Self-Retracting Lifeline

With Aluminum Carabiner (Captive Eye) and Single-Leg Quick Connector x 6 ft. (1.8 m)



3101227

Nano-Lok Self-Retracting Lifeline

With Aluminum Rebar Hook and Single-Leg Quick Connector x 6 ft. (1.8 m)



3101228

Nano-Lok Self-Retracting Lifeline

With Steel Snap Hook and Single-Leg Quick Connector x 6 ft. (1.8 m)



3101229

Nano-Lok Self-Retracting Lifeline

With Single-Leg Quick Connector and Steel Rebar Hook x 6 ft. (1.8 m)



3101254

Nano-Lok Self-Retracting Lifeline

With Aluminum Rebar Hook x 6 ft. (1.8 m)



3M™ DBI-SALA® Nano-Lok™ Twin-Leg Self-Retracting Lifelines

3101273

Nano-Lok Twin-Leg Self Retracting Lifeline

With Twin-Leg Fixed Quick Connector and two Aluminum Rebar Hooks x 6 ft. (1.8 m)



3101277

Nano-Lok Twin-Leg Self-Retracting Lifeline

With Twin-Leg Quick Connector and two Aluminum Rebar Hooks x 6 ft. (1.8 m)



3101279

Nano-Lok Twin-Leg Self-Retracting Lifeline

With two Steel Snap Hooks and Twin-Leg Connector x 6 ft. (1.8 m)



3101280

Nano-Lok Twin-Leg Self-Retracting Lifeline

With Steel Rebar Snap Hooks and Quick Connector x 6 ft. (1.8 m)



3101288

Nano-Lok Twin-Leg Self-Retracting Lifeline

With Twin-Leg Fixed Quick Connector and two Steel Rebar Hooks x 6 ft. (1.8 m)



3101473

Nano-Lok Twin-Leg Self-Retracting Lifeline

With two Aluminum Locking Rebar Hooks x 6 ft. (1.8 m)

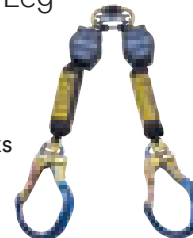

3M™ DBI-SALA® Nano-Lok™ Extended Length Self-Retracting Lifelines

3101582

Nano-Lok Extended Length Quick-Connect Self-Retracting Lifeline

With Anchor Hook x 11 ft. (3.35 m)



3101588

Nano-Lok Extended Length Order Picker Self-Retracting Lifeline

With Snap Hook x 11 ft. (3.35 m)



3101621

Nano-Lok Extended Length Twin-Leg Quick-Connect Self-Retracting Lifeline

With Snap Hook x 11 ft. (3.35 m)



3101590

Nano-Lok Extended Length Quick-Connect Self-Retracting Lifeline

With Aluminum Rebar Hook x 9 ft. (2.74 m)



3101624

Nano-Lok Extended Length Twin-Leg Quick-Connect Self-Retracting Lifeline

With Aluminum Locking Rebar Hooks x 9 ft. (2.74 m)



3101625

Nano-Lok Extended Length Twin-Leg Quick-Connect Self-Retracting Lifeline

With Aluminum Rebar Hooks x 9 ft. (2.74 m)



C Self-Retracting Lifelines

3M™ DBI-SALA® Nano-Lok™ Tie-Back Self-Retracting Lifelines

Selection guide:

	NANO-LOK TIE-BACK SRL	Part #
Single Leg	5,000 lb. gated snap hook with swiveling anchor loop only x 9 ft. (2.7 m)	3101368
	5,000 lb. gated snap hook with aluminum carabiner x 9 ft. (2.7 m)	3101365
	5,000 lb. gated snap hook with single leg connector x 9 ft. (2.7 m)	3101366
	5,000 lb. gated snap hook with steel carabiner x 9 ft. (2.7 m)	3101367
Twin Leg	5,000 lb. gated snap hook with twin leg quick-connector x 9 ft. (2.7 m)	3101374
	5,000 lb. gated snap hook with fixed D-ring connector x 9 ft. (2.7 m)	3101373

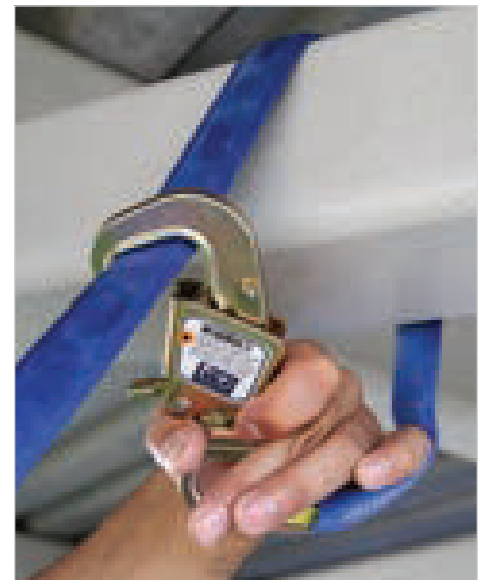
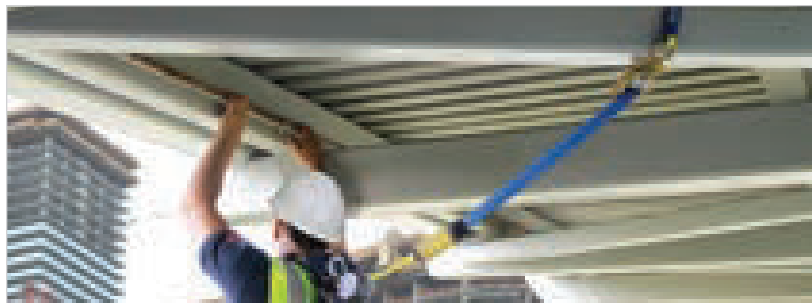

3M™ DBI-SALA® Nano-Lok™ Arc Flash Self-Retracting Lifelines



Designed specifically for utility applications.

- 8 ft. (2.4 m) working length.
- With Nomex®/Kevlar® fiber web lifeline and reinforced edges for improved wear resistance and durability over standard webbing.
- Features an arc flash industry logo to easily identify the product application.
- Arc flash compliant, tested to 40 cal/cm². Meets ASTM F887.
- Meet ASTM F887, ANSI Z359.14, OSHA 1910.140, OSHA 1926.502, ANSI A10.32.



3101575

Selection guide:

	Lifeline hook										Anchorage type			Part #
	Steel Snap Hook	Steel Welding Snap Hook	Steel Rebar Hook	Steel Rebar Look Hook	Aluminum Carabiner	Aluminum Rebar Hook	Aluminum Rebar Look Hook	Dielectric Web Loop	11' Tie-Back	Single-Leg Interface	Twin-Leg Interface	Steel Carabiner	Web Leg w/ Alum. Snap Hook	
8 ft. Single Leg	■									■				3101526
		■									■			3101527
			■								■			3101528
				■							■			3101529
					■						■			3101530
						■					■			3101531
		■								■			■	3101532
8 ft. Twin Leg												■		3101533
									■	■				3101562
														3101563
	■													3101534
		■										■		3101535
			■									■		3101536
				■								■		3101537
Bucket Truck														3101538
														3101539
														3101540
									■					3101541
										■				3101542
														3101543
														3101544
													3101545	
													3101546	
													3101547	
													3101548	
													3101549	
													3101550	
													3101551	
													3101552	
													3101553	
													3101554	
													3101555	
													3101556	
													3101557	
													3101558	
													3101559	
													3101560	
													3101561	
													3101564	
													3101565	
													3101566	
													3101567	
													3101568	
													3101569	
													3101570	
													3101571	
													3101572	
													3101573	
													3101574	
													3101575	

3M™ DBI-SALA® Nano-Lok™ for Hot Work Use Self-Retracting Lifelines



This unique SRL was tested to 8 calories, ensuring durability in applications like welding, grinding and torching. It is reinforced with Kevlar® fiber to withstand sparks, weld splatter and other high heat exposure.

- 6 ft. (1.8 m) working length.
- Universal hot work icon to quickly and easily identify hot work product.
- Equipped with RFID.
- Meets ANSI Z359.14, OSHA 1910.140, OSHA 1926.502, ANSI A10.32.



3101503

Selection guide:

	Lifeline hook										Anchorage type			Part #
	Steel Snap Hook	Steel Welding Snap Hook	Steel Rebar Hook	Steel Rebar Look Hook	Aluminum Carabiner	Aluminum Rebar Hook	Aluminum Rebar Look Hook	9 ft. Tie-Back	Single-Leg Interface	Twin-Leg Interface	Steel Carabiner			
6 ft. Single Leg	■													3101491
		■												3101492
			■											3101493
				■										3101494
					■									3101495
						■								3101496
							■							3101497
6 ft. Twin Leg	■													3101498
														3101322
														3101324
														3101499
														3101500
														3101501
														3101502
													3101503	
													3101504	
													3101505	
													3101326	

3M™ DBI-SALA® Nano-Lok™ edge Self-Retracting Lifelines



In your line of work, anchoring at your feet may be the only option. The Nano-Lok edge SRL is specifically designed for foot level tie-off and sharp edge applications, and meets relevant safety standards. It features a combination of innovative lifeline material, energy absorption, and harness connection to reduce the impact forces on the worker, and the shear forces on the lifeline, in a fall arrest event over a sharp edge.

- Available in single and twin-leg units.
- Easy-to-install connector provides 360 degrees of rotation and leaves the D-ring open for rescue or other equipment.
- Impact-resistant housing provides maximum durability.
- Global sharp edge icon makes identification of sharp edge product quick and easy.
- Tough and flexible lifeline is 8 ft. (2.4 m) of 3/16 in. (5 mm) galvanized cable, providing maximum range of motion, durability and resistance.
- Backpack design stays tight to the harness and evenly distributes the unit's weights.
- Backpack-style energy absorber and connector work together to limit forces on both the worker and the impacted edge.

C Self-Retracting Lifelines

Selection guide:



3500231

	Lifeline hook									SRL
	Tie-back	Alum. Rebar Lock Hook	Steel Rebar Lock Hook	Alum. Rebar Hook	Steel Rebar Hook	Steel Snap Hook	Steel Swivel Snap Hook	Alum. Captive Carabiner	Alum. Snap Hook	Part #
Twin Leg	■									3500228
		■								3500231
			■							3500227
				■						3500249
					■					3500246
						■				3500225
							■			3500226
Single Leg								■		3500229
									■	3500230
	■									3500213
		■								3500216
			■							3500212
				■						3500247
					■					3500248
						■				3500210
							■			3500211
							■		3500214	
								■	3500215	

*All versions are 8 ft. in length except tie-back models. Tie-back versions are 9 ft.

3M™ DBI-SALA® Sealed-Block Self-Retracting Lifelines

Keep grease, dirt and moisture from affecting the performance of your SRL with a sealed self-retracting lifeline. Constructed from heavy-duty, corrosion-resistant materials, the sealed design meets IP68 rating.

- Built-in carrying handle for easy transport is also certified as a secondary fall arrest rated anchorage point.
- Galvanized and stainless steel cable lifeline options.
- Self-locking swivel hook:
 - Limits lifeline twisting
 - Integrated impact indicator
 - 3,600 lb. gate reduces accidental disengagements (“roll-out”)
- Pivoting anchorage loop centers the load.
- Aluminum housing and cast cover help provide exceptional strength, durability and corrosion resistance.
- Anti-ratcheting design stays locked on rigid and non-rigid (horizontal lifeline) anchors.
- 420 lb. weight capacity (all non-RSQ models) option for higher capacity for operator and tools.



3400902

3M™ DBI-SALA® Sealed-Block Self-Retracting Lifelines

Length:
15 ft.

3400825

Galvanized steel wire rope with swivel snap hook, anchorage carabiner.



3400827

Stainless steel wire rope with swivel snap hook, anchorage carabiner.



3M™ DBI-SALA® Sealed-Block Self-Retracting Lifelines

Length:
30 ft.

3400800

Galvanized steel wire rope with swivel snap hook, anchorage carabiner.

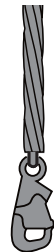

3400802

Stainless steel wire rope with swivel snap hook, anchorage carabiner.



3M™ DBI-SALA® Sealed-Block

Self-Retracting Lifelines

Length:
50 ft.

3400900

Galvanized steel wire rope with swivel snap hook, anchorage carabiner, 4 ft. (1.2 m) cable tie-off adapter.

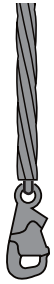

3400902

Stainless steel wire rope with swivel snap hook, anchorage carabiner, 4 ft. (1.2 m) cable tie-off adapter.



3M™ DBI-SALA® Sealed-Block

Self-Retracting Lifeline

Length:
85 ft.

3400860

Galvanized steel wire rope with swivel snap hook, anchorage carabiner, 4 ft. (1.2 m) cable tie-off adapter.



3400862

Stainless steel wire rope with swivel snap hook, anchorage carabiner, 4 ft. (1.2 m) cable tie-off adapter.



3400885

Galvanized steel wire rope with swivel snap hook, RSQ dual-mode, anchorage carabiner, 4 ft. (1.2 m) cable tie-off adapter.



3M™ DBI-SALA® Sealed-Block

Self-Retracting Lifelines

Length:
130 ft.

3400965

Galvanized steel wire rope with swivel snap hook, anchorage carabiner, 4 ft. (1.2 m) cable tie-off adapter.

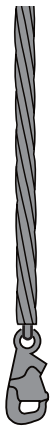

3400967

Stainless steel wire rope with stainless steel swivel snap hook, anchorage carabiner, 4 ft. (1.2 m) cable tie-off adapter.



3400990

Galvanized steel wire rope with swivel snap hook, RSQ dual-mode, anchorage carabiner, 4 ft. (1.2 m) cable tie-off adapter.



3M™ DBI-SALA® Sealed-Block

Self-Retracting Lifelines

Length:
175 ft.

3400650

Galvanized steel wire rope with swivel snap hook, anchorage carabiner, 4 ft. (1.2 m) cable tie-off adapter.



3400652

Stainless steel wire rope with stainless steel swivel snap hook, anchorage carabiner, 4 ft. (1.2 m) cable tie-off adapter.



3M™ DBI-SALA® Ultra-Lok™ Self-Retracting Lifelines

Durable and lightweight, these SRLs are engineered to deliver fall protection efficiency and comfort. Should a fall occur, a speed-sensing brake system will activate, stopping the fall and reducing the imposed forces to 900 lbs. (4 kN) or less.

- Top swivel limits lifeline twisting for smoother operation.
- Lightweight, compact and durable thermoplastic housing.
- Ergonomic cable handle provides added comfort and ease-of-use when making connections.
- Self-locking swivel hook limits lifeline twisting.
- Impact indicator provides visual indication of fall arrest.
- 3,600 lb. gate reduces chances of accidental disengagement (“roll-out”).
- Built to last with stainless steel components and anti-ratcheting brake system.



3M™ DBI-SALA® Ultra-Lok™ Self-Retracting Lifelines

Length:
11 ft.

3103107

1 in. (2.5 cm) nylon web with snap hook.



3103108

1 in. (2.5 cm) nylon web with swivel snap hook.



3M™ DBI-SALA® Ultra-Lok™ Self-Retracting Lifeline

Length:
15 ft.

3504422

Leading Edge



7/32 in. (5.5 mm) galvanized steel wire rope with swivel snap hook.



3M™ DBI-SALA® Ultra-Lok™ Self-Retracting Lifelines

Length:
20 ft.

3103207

1 in. (2.5 cm) nylon web with snap hook.



3103208

1 in. (2.5 cm) nylon web with swivel snap hook.

3103275

Arc Flash



1 in. (2.5 cm) Nomex®/Kevlar® fiber webbing with swivel snap hook.

Length:
20 ft.

3504433

3/16 in. (5 mm) galvanized steel wire rope with swivel snap hook.

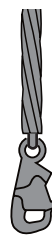

3504434

3/16 in. (5 mm) stainless steel wire rope with swivel snap hook.



3103207



3M™ DBI-SALA® Ultra-Lok™
Self-Retracting Lifelines

Length:
30 ft.

3504500

Leading Edge



7/32 in. (5.5 mm) galvanized steel wire rope with swivel snap hook.

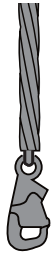

3504430

3/16 in. (5 mm) galvanized steel wire rope with swivel snap hook.

3504431

3/16 in. (5 mm) stainless steel wire rope with swivel snap hook.

3504432

3/16 in. (5 mm) stainless steel wire rope with stainless steel swivel snap hook.



3M™ DBI-SALA® Ultra-Lok™
Self-Retracting Lifelines

Length:
50 ft.

3504450

3/16 in. (5 mm) galvanized steel wire rope with swivel snap hook.

3504451

3/16 in. (5 mm) stainless steel wire rope with swivel snap hook.

3504480

1/4 in. (6 mm) Vectran synthetic rope with swivel snap hook.

3504551

3/16 in. (5 mm) stainless steel wire rope with swivel snap hook and RSQ dual-mode.

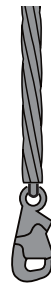

3M™ DBI-SALA® Ultra-Lok™
Self-Retracting Lifeline

Length:
55 ft.

3504600

Leading Edge



7/32 in. (5.5 mm) galvanized steel wire rope with swivel snap hook.



3M™ DBI-SALA® Ultra-Lok™
Self-Retracting Lifeline

Length:
85 ft.

3504485

3/16 in. (5 mm) galvanized steel wire rope with swivel snap hook.

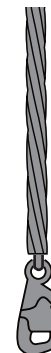

3M™ DBI-SALA® Talon™ Self-Retracting Lifelines

3101001

Talon Quick-Connect Self-Retracting Lifeline

1 in. (2.5 cm) nylon web with swivel snap hook and quick connector for harness mounting x 8 ft. (2.4 m)



3101009

Talon Order Picker Self-Retracting Lifeline

1 in. (2.5 cm) nylon web with swivel snap hook and cab-mount order picker connector x 8 ft. (2.4 m)



3101300

Talon Tie-Back Quick-Connect Self-Retracting Lifeline – Web

1 in. (2.5 cm) nylon web with tie-back hook and quick connector for harness mounting x 9.5 ft. (2.9 m)



3101006

Talon Quick-Connect Self-Retracting Lifeline – Web

1 in. (2.5 cm) nylon web with quick connector and 2109193 Flat Steel Rebar Hook with 2-1/2 in. (62.5 mm) gate opening x 8 ft. (2.4 m)



3M™ DBI-SALA® Talon™ Twin-Leg Self-Retracting Lifelines

3102100

Talon Twin-Leg Tie-Back Quick-Connect Self-Retracting Lifeline – Web

Tie-back type twin-leg lifelines with 1 in. (2.5 cm) nylon web and tie-back hooks, quick connector for harness mounting x 7.5 ft. (2.3 m)



3102000

Talon Twin-Leg Quick-Connect Self-Retracting Lifeline – Web

Twin-leg lifelines with 1 in. (2.5 cm) nylon web, quick connector for harness mounting, aluminum rebar hooks x 6 ft. (1.8 m)

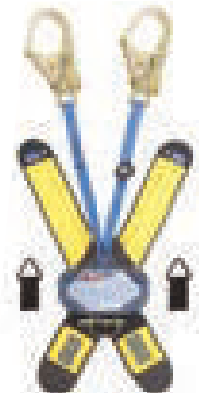

3102003

Talon Twin-Leg Quick-Connect Self-Retracting Lifeline

Twin-leg lifelines with 1 in. (2.5 cm) nylon web, quick connector for harness mounting, steel rebar hooks x 6 ft. (1.8 m)



3102115

Talon Twin-Leg Tie-Back Quick-Connect Self-Retracting Lifeline

Tie-back type twin-leg lifelines with 1 in. (2.5 cm) nylon web and tie-back hooks, quick connector for harness mounting x 8.5 ft. (2.6 m) 420 lb. capacity.



3M™ DBI-SALA® Shock-Absorbing Lanyards

Meeting industry standards.

When you place your trust in a 3M™ DBI-SALA® Lanyard, you can depend on the fact that every one meets rigorous industry safety standards, including OSHA and ANSI Z359.13. That's why workers around the world rely on them for safety, ease-of-use and durability.

Choosing a lanyard

Look for quality in these features when selecting a lanyard.

A. Webbing

Choose your webbing based on the type of conditions you work in. Options include Nomex®/Kevlar® with fiber, polyurethane-coated and cable.

B. Impact indicators

Impact indicators let you know if a shock absorber has been involved in a fall, so you can remove it from service.

C. Connector/hook

3M™ DBI-SALA® Snap Hooks allow one-handed use and won't pinch thumbs or fingers.

D. Length

The standard lanyard length is 6 ft (1.8 m), but other lengths are available.

E. Shock absorber

Most shock absorbers keep forces below 900 lbs. (4 kN) and are available in pack or tubular styles.



C

Shock-Absorbing Lanyards

Types of Hooks

One-handed operation makes our Snap Hooks a popular choice in the industry. Easy to use with or without gloves, no pinched thumbs or fingers. All of our lanyards feature 3,600 lb. (16 kN) rated gates.



See all new products on page 4



	Steel Snap Hook	Aluminum Snap Hook	Aluminum Rebar Hook	Flat Steel Rebar Hook	3M™ DBI-SALA® Saflok™ Max Steel Rebar Hook	Saflok™ Tower Hook	Aluminum Rebar Hook with Locking Nose	Steel Rebar Hook with Locking Nose	Wrap Back Hook	Tie-Back Carabiner	New 3M™ DBI-SALA® Comfort Grip Hook
Gate Opening	3/4 in. (19 mm)	3/4 in. (19 mm)	2-1/4 in. (57 mm)	2-1/2 in. (62.5 mm)	3 in. (76.2 mm)	4-5/16 in. (116.84 mm)	2-1/2 in. (62.5 mm)	2-1/2 in. (62.5 mm)	3/4 in. (19 mm)	3/4 in. (19 mm)	2-1/4 in. (57 mm)
Gate Strength	3,600 lb. (16 kN)	3,600 lb. (16 kN)	3,600 lb. (16 kN)	3,600 lb. (16 kN)	3,600 lb. (16 kN)	3,600 lb. (16 kN)	3,600 lb. (16 kN)	3,600 lb. (16 kN)	3,600 lb. (16 kN)	3,600 lb. (16 kN)	3,600 lb. (16 kN)

Shock-Absorbing Lanyards

Types of Lanyards



Pack-Style Shock-Absorbing Lanyards

These basic lanyards dissipate energy, limiting the forces on the body in a fall arrest event.



Tubular-Style Shock-Absorbing Lanyards

These lanyards are available in both fixed length and “stretch” style designs.



Twin-Leg Lanyards

Twin-Leg lanyards provide 100% tie-off, allowing users to stay protected when changing locations.



Positioning Lanyards

Designed without shock absorbers for positioning or restraint applications.



Tie-Back Lanyards

Tie-Back lanyards act as both a connecting means and an anchorage connector when a qualified anchorage connector is not available.



Lanyards for Arc Flash and Hot Work Use



These lanyards are designed with Kevlar® fiber for use in high temperatures or applications requiring arc flash protection.



Lanyards for Foot-Level Tie-Off

Used at the feet, these lanyards allow a 12 ft. (3.7 m) free fall and maintain forces below 1,800 lbs. (8 kN)



Fall-Restricting Device

Clinches around a wood pole during “cut outs” to help prevent users from falling and allowing them to regain footing.

3M™ DBI-SALA® ShockWave™2 Shock-Absorbing Lanyards

Avoid trips and snags with lanyards that expand and contract (6 ft.-4-1/2 ft.) in reaction to movement. They have a built-in impact indicator and limit the average fall arresting forces to 900 lbs. (4 kN)

Selection guide:



1244409

Part #	Single-Leg/ Twin-Leg	Hook 1 (Harness) Material/Style	Hook 2 (Anchor) Material/Style	Hook 3 (Anchor) Material/Style
1244306	Single	Steel/Snap	Steel/Snap	-
1244311	Single	Aluminum/Snap	Aluminum/Rebar Locking Nose	-
1244321	Single	Steel/Snap	Steel/Rebar Locking Nose	-
1244360	Single	Steel/Snap	Steel/Saflok™ Max Rebar	-
1244406	Twin	Steel/Snap	Steel/Snap	Steel/Snap
1244409	Twin	Aluminum/Snap	Aluminum/Rebar Locking Nose	Aluminum/Rebar Locking Nose
1244412	Twin	Steel/Snap	Steel/Rebar Locking Nose	Steel/Rebar Locking Nose

All lanyards are 6 ft. long unless otherwise noted.

3M™ DBI-SALA® ShockWave™2

Shock-Absorbing Lanyards

Rescue Lanyards

These lanyards incorporate an integrated D-ring to help facilitate the rescue of a fallen worker.



1244456

Arc Flash Lanyards



Constructed from unique materials, these lanyards have Nomex®/Kevlar® fiber and are great for high heat environments or for electrical work when arc flash is a concern. Meets arc requirements of ASTM F887.



1244610





Tie-Back Lanyards

When a qualified anchorage connector is not available, a tie-back lanyard acts as both a connecting means and an anchorage connector.



1244650

Selection guide:

Part #	Type	Single-Leg/ Twin-Leg	Hook 1 (Harness) Material/Style	Hook 2 (Anchor) Material/Style	Hook 3 (Anchor) Material/Style
1244456	Rescue	Twin	Steel/Snap, D-ring	Steel/Rebar Locking Nose	Steel/Rebar Locking Nose
1244750	Rescue	Twin	Steel/Snap	Steel/Rebar Locking Nose, D-ring	Steel/Rebar Locking Nose, D-ring
1244455	Rescue	Twin	Steel/Snap, D-ring	Steel/Snap	Steel/Snap
1244459	Rescue	Twin	Steel/Snap, D-ring	Steel/Saflok™ Max Rebar	Steel/Saflok™ Max Rebar
1244751	Rescue	Twin	Aluminum/Snap	Aluminum/Rebar Locking Nose, D-ring	Aluminum/Rebar Locking Nose, D-ring
1244610	Arc Flash 	Single	Steel/Snap	Steel/Snap	-
1244611	Arc Flash 	Single	Web Choker	Steel/Snap	-
1244630	Arc Flash 	Twin	Steel/Snap	Steel/Snap	Steel/Snap
1244631	Arc Flash 	Twin	Web Choker	Steel/Snap	Steel/Snap
1244632	Arc Flash 	Twin	Aluminum/Snap	Aluminum/Rebar Locking Nose	Aluminum/Rebar Locking Nose
1244639	Arc Flash 	Twin	Aluminum/Snap	Steel/Saflok™ Max Rebar	Steel/Saflok™ Max Rebar
1244650	Tie-Back	Single	Steel/Snap	Steel/Tie-back Carabiner	-
1244675	Tie-Back	Twin	Steel/Snap	Steel/Tie-back Carabiner	Steel/Tie-back Carabiner

Shock-Absorbing Lanyards

3M™ DBI-SALA® EZ-Stop™

Shock-Absorbing Lanyards

Using a controlled tearing action, these lanyards limit the average fall arrest forces to 900 lbs. (4 kN) or less.



1246021

Selection guide:

Part #	Single-Leg/ Twin-Leg	Leg Material	Hook 1 (Harness) Material/Style	Hook 2 (Anchor) Material/Style	Hook 3 (Anchor) Material/Style
1246021	Twin	Web	Aluminum/Snap	Aluminum/Rebar Locking Nose	Aluminum/Rebar Locking Nose
1246022	Twin	Web	Steel/Snap	Steel/Snap	Steel/Snap
1246024	Twin	Web	Steel/Snap	Steel/Rebar Locking Nose	Steel/Rebar Locking Nose
1246100	Single	Web	Steel/Snap	Steel/Carabiner 2-3/16 in. Gate Opening	-
1246101	Single	Web	Steel/Snap	Steel/Saflok™ Max Rebar	-
1246103	Single	Web	Aluminum/Snap	Aluminum/Rebar Locking Nose	-
1246113	Twin	Web	Steel/Snap	Steel/Saflok™ Max Rebar	Steel/Saflok™ Max Rebar
1246011	Single	Web	Steel/Snap	Steel/Snap	-
1246188	Single	Cable, Vinyl Coated	Steel/Snap	Steel/Snap	-
1246193	Twin	Web, Elastic	Aluminum/Snap	Aluminum/Rebar Locking Nose	Aluminum/Rebar Locking Nose
1246196	Twin	Web, Elastic	Steel/Snap	Steel/Snap	Steel/Snap
1246200	Single	Web, Elastic	Steel/Snap	Steel/Snap	-
1246234	Single	Web, Adjustable	Steel/Snap	Steel/Snap	-
1246213	Twin	Web, Coated	Steel/Snap	Steel/Snap	Steel/Snap
1246226	Single	Web, Coated	Steel/Snap	Steel/Snap	-
1246104	Single	Web	Web Choker	Steel/Snap	-

3M™ DBI-SALA® EZ-Stop™

Shock Absorber

Add in-line to your existing non-shock-absorbing lanyard to help make it safe for fall arrest applications.

Selection guide:

Part #	Leg Material	Hook 1 (Harness) Material/Style	Hook 2 (Anchor) Material/Style
1246177	Web	Steel/Snap	D-ring



1246177

3M™ DBI-SALA® EZ-Stop™

Tie-Back Lanyards

When a qualified anchorage connector is not available, a tie-back lanyard acts as both a connecting means and an anchorage connector.



1246088

Selection guide:

Part #	Type	Single-Leg/ Twin-Leg	Leg Material	Hook 1 (Harness) Material/Style	Hook 2 (Anchor) Material/Style	Hook 3 (Anchor) Material/Style
1246070	Tie-Back	Twin	Web	Steel/Snap	Steel/Snap	Steel/Snap
1246071	Tie-Back	Twin	Web	Aluminum/Snap	Aluminum/Rebar Locking Nose	Aluminum/Rebar Locking Nose
1246072	Tie-Back	Twin	Web	Steel/Snap	Steel/Rebar Locking Nose	Steel/Rebar Locking Nose
1246085	Tie-Back	Single	Web	Steel/Snap	Steel/Snap	-
1246088	Tie-Back	Single	Web	Aluminum/Snap	Aluminum/Rebar Locking Nose	-
1246089	Tie-Back	Single	Web	Steel/Snap	Steel/Rebar Locking Nose	-
1246203	Tie-Back	Twin	Web, Coated	Steel/Snap	Steel/Snap	Steel/Snap

3M™ DBI-SALA® EZ-Stop™

Leading Edge Shock-Absorbing Lanyards

Engineered for sharp edges, these lanyards incorporate edge certified cable construction and offer Force™2 foot-level tie-off ability (for maximum 12 ft. free fall).



Selection guide:

Part #	Type	Single-Leg/ Twin-Leg	Leg Material	Hook 1 (Harness) Material/Style	Hook 2 (Anchor) Material/Style	Hook 3 (Anchor) Material/Style
1246066	Leading Edge	Single	Cable, Vinyl Coated	Steel/Snap	Steel/Snap	-
1246068	Leading Edge	Twin	Cable, Vinyl Coated	Aluminum/Snap	Aluminum/Snap	Aluminum/Snap
1246178	Leading Edge	Twin	Cable, Vinyl Coated	Aluminum/Snap	Aluminum/Rebar Locking Nose	Aluminum/Rebar Locking Nose
1246261	Leading Edge	Single	Cable, Vinyl Coated	Steel/Snap	Steel/Rebar Locking Nose	-

3M™ DBI-SALA® EZ-Stop™

Lanyards for Arc Flash and Hot Work Use

Constructed from materials great for high heat environments or for electrical work when arc flash is a concern. Meets arc requirements of ASTM F887.



Selection guide:

Part #	Type	Single-Leg/ Twin-Leg	Leg Material	Hook 1 (Harness) Material/Style	Hook 2 (Anchor) Material/Style	Hook 3 (Anchor) Material/Style
1246306	Arc Flash	Single	Nomex®/Kevlar®	Steel/Snap	Steel/Snap	-
1246307	Arc Flash	Single	Nomex®/Kevlar®	Aluminum/Snap	Aluminum/Rebar Locking Nose	-
1246310	Arc Flash	Single	Nomex®/Kevlar®, Coated	Steel/Snap	Steel/Snap	-
1246311	Arc Flash	Single	Nomex®/Kevlar®, Coated	Web Choker	Steel/Snap	-
1246317*	Arc Flash	Single	Nomex®/Kevlar®, Adjustable	Steel/Snap	Steel/Snap	-
1246318*	Arc Flash for Foot-Level Tie Off	Single	Nomex®/Kevlar®, Adjustable	Aluminum/Snap	Aluminum/Rebar Locking Nose	-
1246320*	Arc Flash for Foot-Level Tie Off	Twin	Nomex®/Kevlar®, Adjustable	Steel/Snap	Steel/Snap	Steel/Snap
1246321*	Arc Flash for Foot-Level Tie Off	Twin	Nomex®/Kevlar®, Adjustable	Aluminum/Snap	Aluminum/Rebar Locking Nose	Aluminum/Rebar Locking Nose
1246352*	Arc Flash for Foot-Level Tie Off	Twin	Nomex®/Kevlar®, Adjustable	Aluminum/Snap	Steel/Saflok™ Max Rebar	Steel/Saflok™ Max Rebar
1246324	Arc Flash Tie-Back	Twin	Nomex®/Kevlar®	Steel/Snap	Steel/Snap	Steel/Snap

*Force™2, foot-level tie off.

3M™ DBI-SALA® EZ-Stop™

Retractable Lanyards

Unique spring technology retracts and expands from 2-1/2 ft.-6 ft. in reaction to user's movements.



Selection guide:

Part #	Type	Single-Leg/ Twin-Leg	Leg Material	Hook 1 (Harness) Material/Style	Hook 2 (Anchor) Material/Style	Hook 3 (Anchor) Material/Style
1241460	Retractable	Single	Web	Steel/Snap	Steel/Snap	-
1241461	Retractable	Single	Web	Steel/Snap	Steel/Rebar	-
1241462	Retractable	Single	Web	Steel/Snap	Aluminum/Rebar	-
1241480	Retractable	Twin	Web	Steel/Snap	Steel/Snap	Steel/Snap
1241481	Retractable	Twin	Web	Steel/Snap	Steel/Rebar	Steel/Rebar
1241482	Retractable	Twin	Web	Steel/Snap	Aluminum/Rebar	Aluminum/Rebar

Shock-Absorbing Lanyards

3M™ DBI-SALA® Force™2

Foot-Level Tie Off Shock-Absorbing Lanyards

Great for when there is no overhead anchorage and your only option is to tie off at your feet. These lanyards can be used for up to a 12 ft. (3.7 m) free fall and limit the average fall arrest forces below 1,800 lbs. (8 kN)

Selection guide:

Part #	Single-Leg/ Twin-Leg	Leg Material	Hook 1 (Harness) Material/Style	Hook 2 (Anchor) Material/Style	Hook 3 (Anchor) Material/Style
1246143	Twin	Web, Elastic	Steel/Snap	Steel/Saflok™ Max Rebar	Steel/Saflok™ Max Rebar
1246145	Twin	Web, Elastic	Aluminum/Snap	Aluminum/Rebar Locking Nose	Aluminum/Rebar Locking Nose
1246147	Twin	Web, Elastic	Steel/Snap	Steel/Snap	Steel/Snap
1246159	Twin	Web	Steel/Snap	Steel/Rebar Locking Nose	Steel/Rebar Locking Nose
1246161	Twin	Web	Steel/Snap	Steel/Snap	Steel/Snap
1246167	Single	Web	Steel/Snap	Steel/Snap	-
1246272	Twin	Rope	Steel/Snap	Steel/Rebar Locking Nose	Steel/Rebar Locking Nose
1246273	Twin	Rope	Aluminum/Snap	Aluminum/Rebar Locking Nose	Aluminum/Rebar Locking Nose

3M™ DBI-SALA® Force™2

Foot-Level Tie Off Shock-Absorber

Add in-line to your existing non-shock-absorbing lanyard to help make it safe for fall arrest applications x 1.3 ft.

Selection guide:

Part #	Single-Leg/ Twin-Leg	Leg Material	Hook 1 (Harness) Material/Style	Hook 2 (Anchor) Material/Style
1246130	Single	Web	Steel/Snap	D-ring



1246130

3M™ DBI-SALA® Wrap Back

Tie-Back Lanyards

These lanyards can help eliminate the need for a separate anchorage connector, improving both your bottom line and compliance. They offer a unique 5,000 lb. (22 kN) hook and heavy-duty webbing.

Selection guide:

Part #	Single-Leg/ Twin-Leg	Leg Material	Hook 1 (Harness) Material/Style	Hook 2 (Anchor) Material/Style	Hook 3 (Anchor) Material/Style
1246075*	Twin	Web	Steel/Snap	Steel/Wrap Back	Steel/Wrap Back
1246080	Twin	Web	Steel/Snap	Steel/Wrap Back	Steel/Wrap Back
1246173*	Single	Web	Steel/Snap	Steel/Wrap Back	-
1246229	Single	Web	Steel/Snap	Steel/Wrap Back	-



1246229

*Force™2, foot-level tie off.

3M™ DBI-SALA® Force™2 Wind Energy

Foot-Level Tie Off Lanyards

Selection guide:

Part #	Single-Leg/ Twin-Leg	Leg Material	Hook 1 (Harness) Material/Style	Hook 2 (Anchor) Material/Style	Hook 3 (Anchor) Material/Style
1246030	Twin	Web, Elastic	Steel/Snap	Steel/Rebar Locking Nose	Steel/Rebar Locking Nose
1246032	Twin	Web, Elastic	Aluminum/Snap	Aluminum/Rebar Locking Nose	Aluminum/Rebar Locking Nose
1246152	Twin	Web, Elastic	Steel/Snap	Steel/Saflok™ Max Rebar	Steel/Saflok™ Max Rebar
1246153	Twin	Web, Elastic	Aluminum/Snap	Aluminum/Rebar Locking Nose	Aluminum/Rebar Locking Nose



1246032

Positioning Web & Rope Lanyards

3M™ DBI-SALA® Positioning Web & Rope Lanyards

Lanyards without shock absorbers, such as rope or web lanyards are designed for positioning or restraint applications.



Selection guide:

Part #	Length	Leg Material	Hook 1 (Harness) Material/Style	Hook 2 (Anchor) Material/Style
1232354	6 ft. (1.8 m)	Rope, Nylon	Steel/Snap	Steel/Snap
1232209	6 ft. (1.8 m)	Rope, Nylon, Adjustable	Steel/Snap	Steel/Snap
1231102	2 ft. (0.6 m)	Web	Steel/Snap	Steel/Snap
1231103	3 ft. (0.9 m)	Web	Steel/Snap	Steel/Snap
1231104	4 ft. (1.2 m)	Web	Steel/Snap	Steel/Snap
1231106	6 ft. (1.8 m)	Web	Steel/Snap	Steel/Snap
1231016	6 ft. (1.8 m)	Web, Adjustable	Steel/Snap	Steel/Snap
1234070	8 ft. (2.4 m)	Rope, Technora® Kernmantle, Adjustable	Steel/Snap	Steel/Rope Adjuster with Carabiner
1234071	8 ft. (2.4 m)	Rope, Technora® Kernmantle, Adjustable	Aluminum/Snap	Aluminum/Rope Adjuster with Carabiner
1234083	8 ft. (2.4 m)	Rope, Technora® Kernmantle, Adjustable	Aluminum/Carabiner	Aluminum/Rope Adjuster with Carabiner
1234080	8 ft. (2.4 m)	Rope, Technora® Kernmantle, Adjustable	Aluminum/Carabiner	Aluminum/Rope Adjuster with Carabiner

3M™ DBI-SALA® Chain & Web Rebar Positioning Lanyards

Made of twist link chain or polyester web for strength and durability. A variety of hook options provide a compatible connection to many types of structures.

5920059
Chain Rebar Assembly
With snap hooks and swiveling Safflok™ Max Hook at center x 24 in. (60 cm)

5920059



5920050
Chain Rebar Lanyard
Chain rebar assembly with snap hooks and swiveling flat steel rebar hook at center x 1.7 ft. (52 cm)

5920051
Chain Rebar Lanyard
Chain rebar assembly with snap hooks and swiveling aluminum rebar hook at center x 22 in. (56 cm)

1231380
Web Rebar Assembly
With snap hooks and aluminum rebar hook at center x 18 in. (45 cm)

1231380



1231389
Web Rebar Lanyard
Web rebar assembly with snap hooks and Safflok Max Hook at center x 22 in. (45 cm)

1231520
Web Rebar Lanyard
Web rebar assembly with snap hooks and swiveling aluminum hook at center x 22 in. (56 cm)

Fall-Restricting Devices

3M™ DBI-SALA® Cynch-Lok™

Fall-Restricting Devices

Easily adjust and cinch around poles during “cut-outs” and easily hitch-hike poles (move or jump the strap upwards past obstacles) with a hand position that’s comfortable. Meets CSA Z259.14 for Type A and AB (dry, wet and icy poles) and ASTM F887.

Selection guide:

Part #	Description	Pole Size Minimum (Dia./Circ.)	Pole Size Maximum (Dia./Circ.)	Weight
1200110	Replacement Strap for Distribution Poles	5-1/2 in./17-1/2 in.	18-1/2 in./58 in.	1.9 lbs. (.86 kg)
1204057	Rope for Distribution Poles	5-1/2 in./17-1/2 in.	18-1/2 in./58 in.	4.8 lbs. (2.1 kg)
1204075	Web for Distribution Poles	5-1/2 in./17-1/2 in.	18-1/2 in./58 in.	4.9 lbs. (2.2 kg)
1200111	Replacement Strap for Transmission Poles	5-1/2 in./17-1/2 in.	30-1/2 in./96 in.	2.4 lbs. (1.1 kg)
1204058	Rope for Transmission Poles	5-1/2 in./17-1/2 in.	30-1/2 in./96 in.	5.3 lbs. (2.4 kg)
1204076	Web for Transmission Poles	5-1/2 in./17-1/2 in.	30-1/2 in./96 in.	5.4 lbs. (2.4 kg)



1204057



1204075

1200115
Cynch-Lok
Replacement Rope
Interior Strap
Weight: 2.9 lbs. (1.3 kg)

1200136
Cynch-Lok
Replacement Web
Interior Strap
Weight: 3 lbs. (1.3 kg)

1204077
Cynch-Lok
Left Carabiner
Conversion
Kit - Web

1204074
Cynch-Lok
Left Carabiner
Conversion
Kit - Rope





As One.

Trusted partners.
Innovative solutions.
A safer world.



With the addition of the knowledgeable people and reliable products of Scott Safety to the 3M team, we're able to offer more safety equipment than ever before—including an expanded portfolio of respiratory solutions for confined spaces and rescue applications. Together, we'll build on Scott Safety's legacy of trusted protection with enhanced technology, so your team can keep getting the job done and keep coming back home safely.

See what's next at
3M.com/ScottSafety.
[#3MxScottSafety](https://twitter.com/3MxScottSafety)

A photograph showing a worker in a white hard hat and high-visibility vest being lowered or raised in a confined space. The worker is suspended by a green rescue system. Other workers in high-visibility gear are visible in the background, assisting with the operation. The scene is dimly lit, emphasizing the confined nature of the space.

Get in easily. Get out safely.

Confined Space Rescue

Our extensive line of high quality, rugged rescue and retrieval systems are proven and trusted by safety engineers and site directors alike to rescue workers in confined spaces quickly and flawlessly—every time.

What to look for in a confined space rescue system:

Ease-of-use

Systems must have the ability to handle a crisis simply and immediately.

Mechanical systems

Lifeline types and length are just a few of the options you need to consider.

Durability

Components must be made from quality materials that can endure rough handling and harsh environments.

Versatility

Systems should be adjustable and adaptable to extreme environments. Modular systems allow you to add to your system over time.

Strength

Systems must be rated for your application. Look for maximum strength with minimal weight.

Portability

Systems should be lightweight and easy to transport, set up and store.

3M™ DBI-SALA® Hoist Systems



Engineered with lightweight materials like high-strength aluminum, 3M™ DBI-SALA® Hoist Systems are adjustable and extendable to meet the specific needs of your job site. Let us help you with a customized solution to maximize ease-of-rescue—even in complex environments.



8530352

4-in-1 Davit Guard System

Provides a basic hoist and a passive restraint guardrail system protecting companion workers and bystanders. It offers ample room for worker entry and maneuvering while keeping the confined space opening secure. A standard tie-off point provides a convenient 5,000 lb. (22 kN) anchor point for fall arrest devices where required.

8518000

3M™ DBI-SALA® 5-Piece Hoist System

Davit arm and base system includes 11.5 in.-27.5 in. (29.2 cm-69.8 cm) Adjustable Offset Upper Mast (8518001), 33 in. (83.8 cm) Lightweight Lower Mast (8518002), and 3-Piece Lightweight Base (8518005). Includes winch mounting bracket. Order winch and Self-Retracting Lifeline separately. Weight: 100 lbs. (45.5 kg)

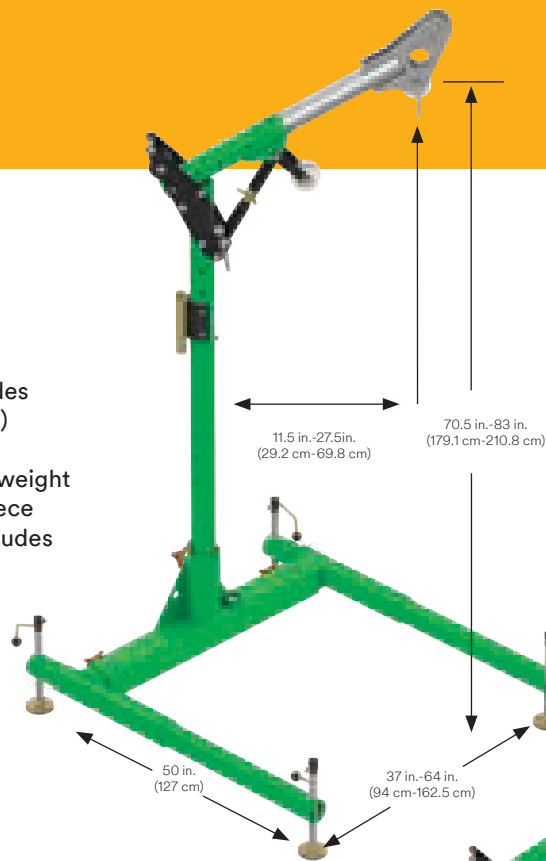

8518040

5-Piece Hoist System

Davit arm and base system includes 23.5 in.-42.5 in. (59.7 cm-108 cm) Adjustable Offset Upper Mast (8518006), 33 in. (83.8 cm) Lightweight Lower Mast (8518002), and 3-Piece Lightweight Base (8518008). Includes winch mounting bracket. Order winch separately. Weight: 137.5 lbs. (62.3 kg)

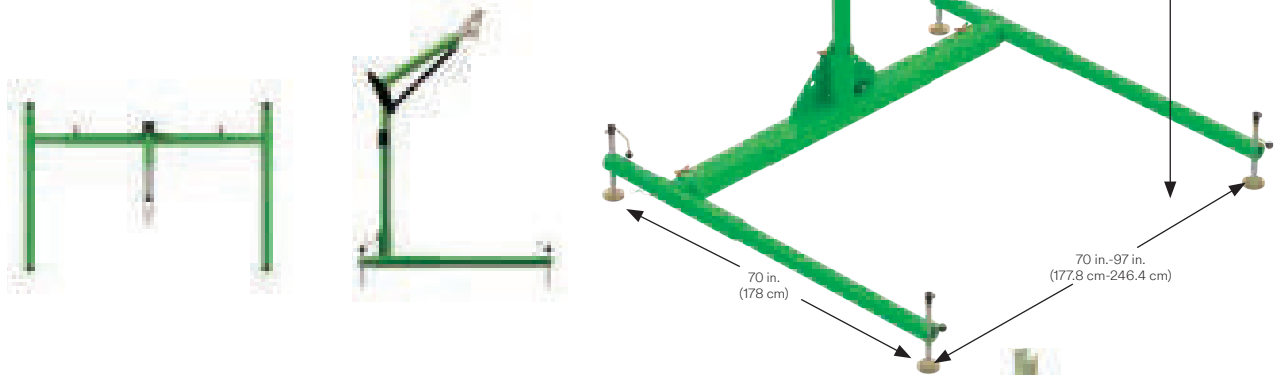

Accessories

8518270

5-Piece Equipment Cart

Transport the 5-Piece System with maximum ease over smooth or rough terrain. Ideal for tight storage situations.

8518513 Set of two carrying bags for 5-Piece Hoist System (8518000)



3M™ DBI-SALA® Davit Arm System Components

Variable offset davits are designed for use where multiple offset masts are required. For applications with overhead clearance restrictions, the adjustable height of the variable offset masts can eliminate the need for custom length masts and mast extensions.

1 Winch

Davits can be equipped with both primary and secondary (back-up) mechanical devices.

2 Quick-Release Mounting Bracket

Detent-style brackets make installation fast and efficient. (See page 101).

3 3-Way SRL

Davits can be equipped with both primary and secondary (back-up) mechanical devices.

4 Lower Mast Extensions

Allows the user to increase the anchorage height.

5 Base Options

Portable and fixed bases are available.

6 Variable Offset Mast

Ensures lifelines are always centered over confined space.

7 Built-In Pulleys

Route lifelines of two mechanical devices.

8 Fall Arrest Anchorage

Up to a 5,000 lb. (22 kN) rated anchor point for fall arrest device.

9 Adjustable Height

Eliminates the need for custom length masts and extensions.

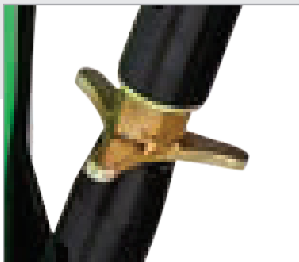
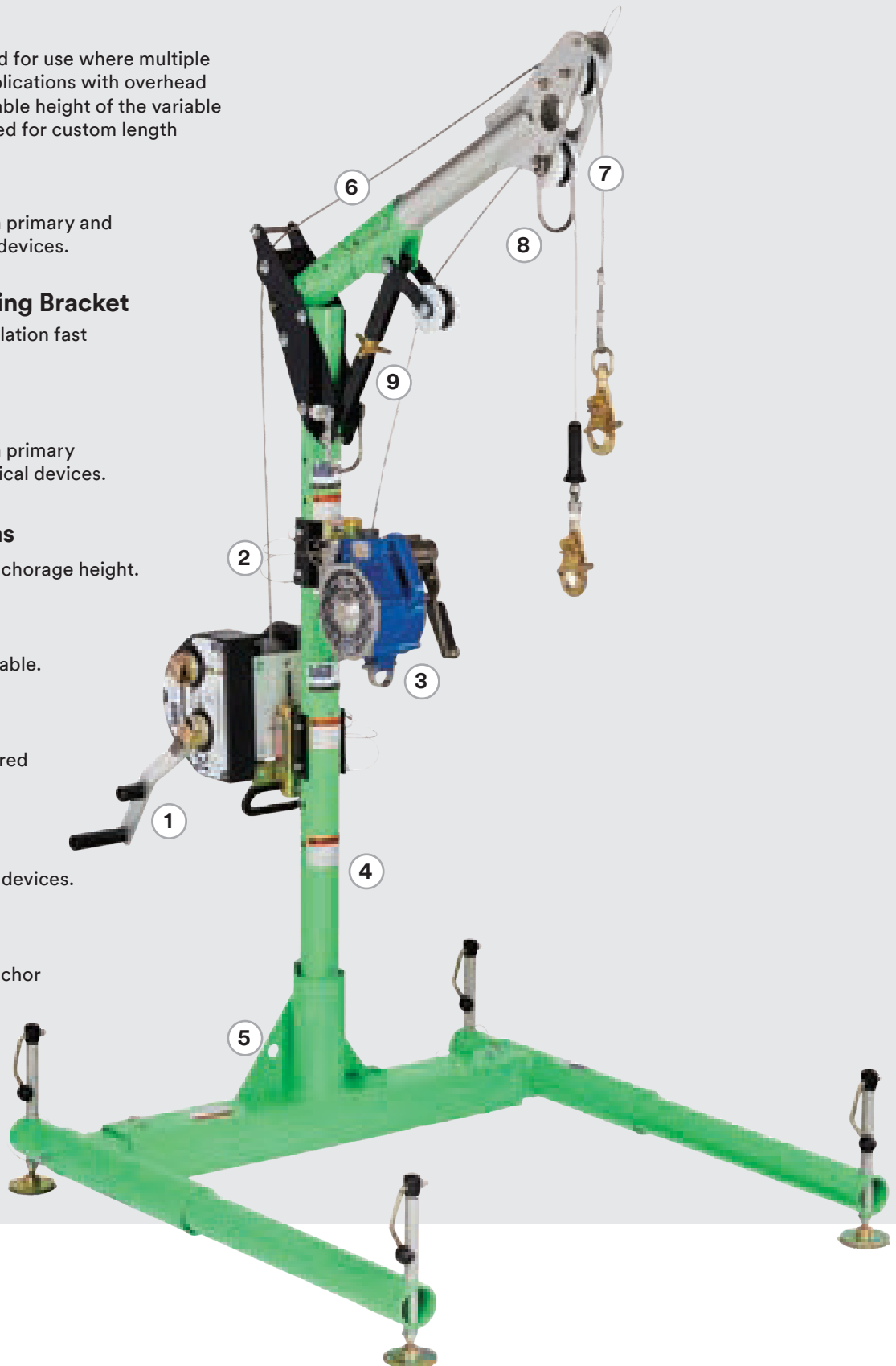

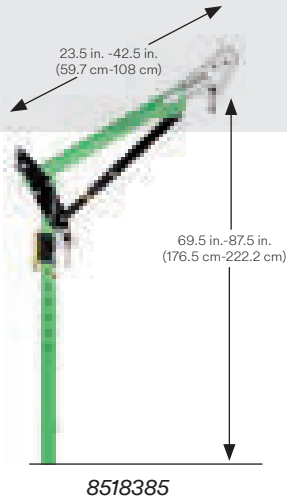

3M™ DBI-SALA® One-Piece Adjustable Offset Davit Masts

Adjustable offset davit mast	66 in.-76 in. (167.6 cm-193 cm)	78 in.-88 in. (198.1 cm-223.5 cm)	90 in.-100 in. (228.6 cm-254 cm)	69.5 in.-87.5 in. (176.5 cm-222.2 cm)	81.5 in.-91.5 in. (207 cm-232.4 cm)	93.5 in.-111.5 in. (237.5 cm-282.2 cm)
11.5 in.-27.5 in. (29.2 cm-69.8 cm)	8518382	8518383	8518384	-	-	-
223.5 in.-42.5 in. (59.7 cm-108 cm)	-	-	-	8518385	8518386	8518387

Offset Davit Masts & Lower Mast Extensions

Customize the height of these davit masts with up to two Lower Mast Extensions. Custom lengths are available—call us for details.

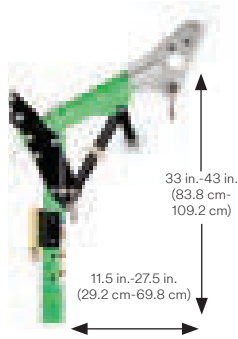

8518001

11.5 in.-27.5 in. Adjustable Offset Davit Mast

(Includes winch mount bracket.) Combine with up to two lower mast extensions to increase anchorage height. Combined extension length cannot exceed 90 in. (228 cm).

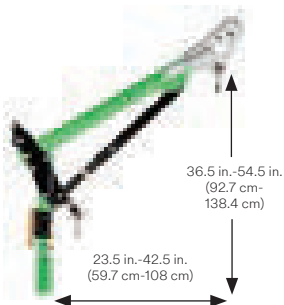

8518006

23.5 in.-42.5 in. Adjustable Offset Davit Mast

(Includes winch mount bracket.) Combine with up to two lower mast extensions to increase anchorage height. Combined extension length cannot exceed 78 in. (198 cm).

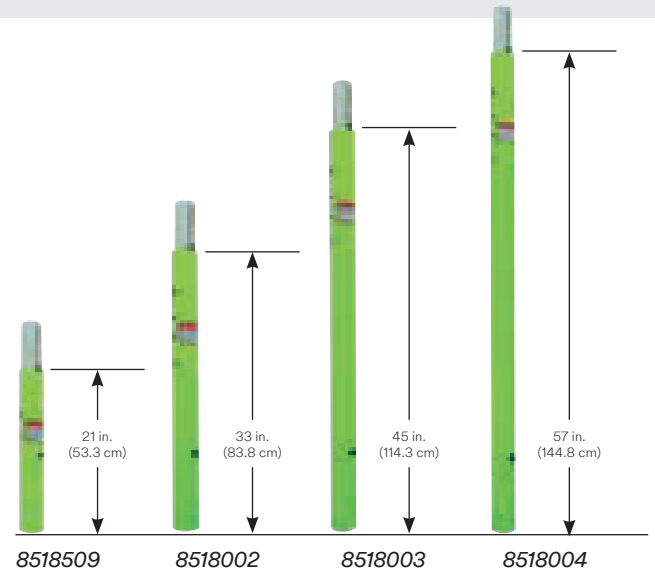

8518509 21 in. (53.3 cm) Lower Mast Extension.

8518002 33 in. (83.8 cm) Lower Mast Extension.

8518003 45 in. (114.3 cm) Lower Mast Extension.

8518004 57 in. (144.8 cm) Lower Mast Extension.

Accessories

8513330

Carrying Bag

Bag with protective plastic liner for Adjustable Offset Davit Mast and 10 ft. aluminum tripod (8513159).

8513564 Bag with protective plastic liner for Adjustable Offset Davit Mast, with Lower Mast Extension.



3M™ DBI-SALA® Fixed Bases

Fixed bases allow for easier setup and teardown, making them ideal for work areas where a base can be permanently installed to an existing structure. All bases come with PVC sleeve liners.

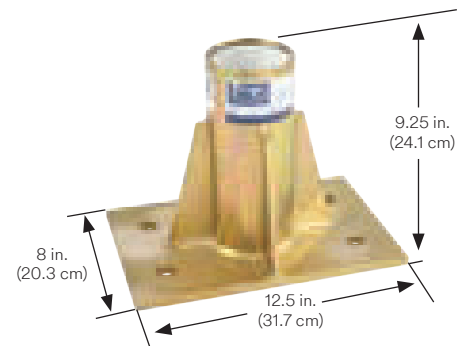

8512831

Center Mount Sleeve
Zinc-Plated

Mild steel construction. Mounts to concrete or steel structure.
Weight: 13 lbs. (5.9 kg)

8516563 304 Stainless steel construction. Mounts to concrete or steel structure.

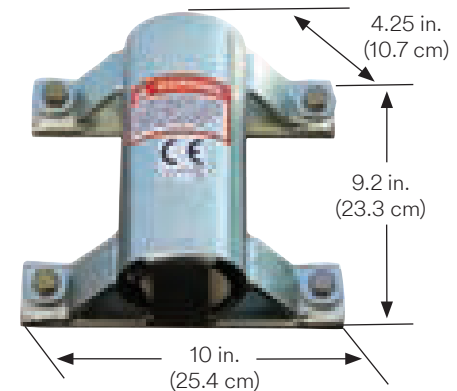

8518348

Wall Mount Sleeve 304
Stainless Steel

304 stainless steel construction. Compact design mounts to vertical concrete or steel structures.
Weight: 12 lbs. (5.5 kg)

8516191 Wall Mount Sleeve, zinc-plated mild steel construction.

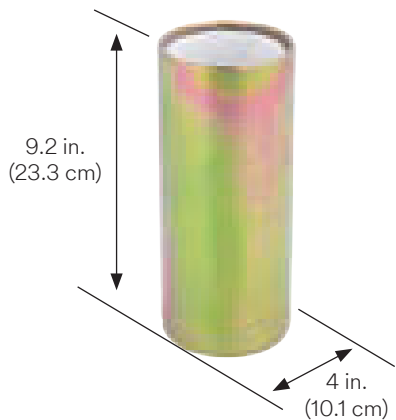

8510109

Core Mount Sleeve

Zinc-plated mild steel construction. Designed for slip-in installation into 4 in. (10.1 cm) core hole in concrete or in an existing steel structure. Weight: 8 lbs. (3.6 kg)

8510110 Core Mount Sleeve, stainless steel construction.

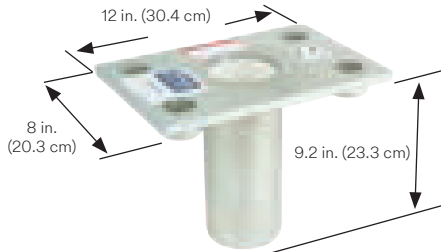

8510316

Floor Mount Sleeve

Mild steel construction. Recessed fastener pockets allow for bolt-in installation into existing concrete or steel structure. Flush mount design eliminates trip hazards when not in use. Weight: 21 lbs. (9.5 kg)

8512827 Flush Floor Mount Sleeve, stainless steel construction.

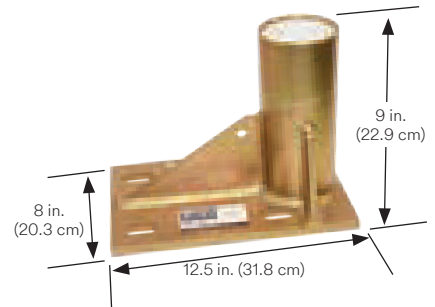

8510057

Offset Floor Mount Sleeve

Zinc-plated mild steel construction. Mounts to horizontal concrete or steel structure. Offset design allows for maximum reach of the mast being used. Weight: 25 lbs. (11.3 kg)

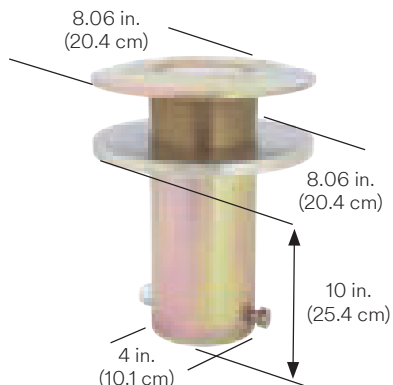

8515162

Deck Mount Sleeve

Zinc-plated mild steel construction. Designed to slip into a 4 in. (10.1 cm) hole in existing flooring. Flush mount design eliminates trip hazards when not in use. Comes with plastic stopper and mounting hardware—mounts to thicknesses from 1/4 in.-2 in. (6.4 mm-50.8 mm). Weight: 17 lbs. (7.7 kg)

8515834 Deck Mount Sleeve, stainless steel construction.

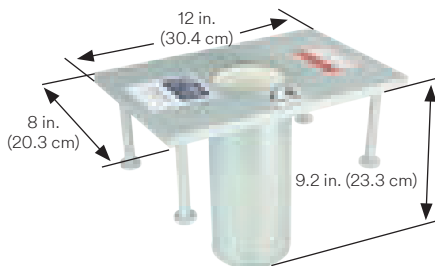

8510311

Flush Floor Mount Sleeve

Mild steel construction. Comes with pins for fresh concrete anchors for new construction or renovation. Flush mount design eliminates trip hazards when not in use. Weight: 21 lbs. (9.5 kg)

8512828 Flush Floor Mount Sleeve, stainless steel construction.



8510827

Heavy-Duty Sleeve Cap

Stainless steel construction. Used with permanent mounted sleeves when installed in high traffic or other severe service locations. Weight: 1.2 lbs. (0.54 kg)

8510826 Heavy-Duty Sleeve Cap, zinc-plated mild steel construction.

3M™ DBI-SALA® Portable Bases

Portable Bases work with a variety of Davit Arm and Mast Extensions. They're ideal when you need to move and access various confined space areas. Bases are lightweight, easy to transport, set up and use.

8518005

3-Piece Portable Base

Adjustable base for 27.5 in. (69.8 cm) maximum offset davit mast.

8518008 3-Piece Portable Base.

Adjustable base for 42.5 in. (108 cm) maximum offset davit mast.

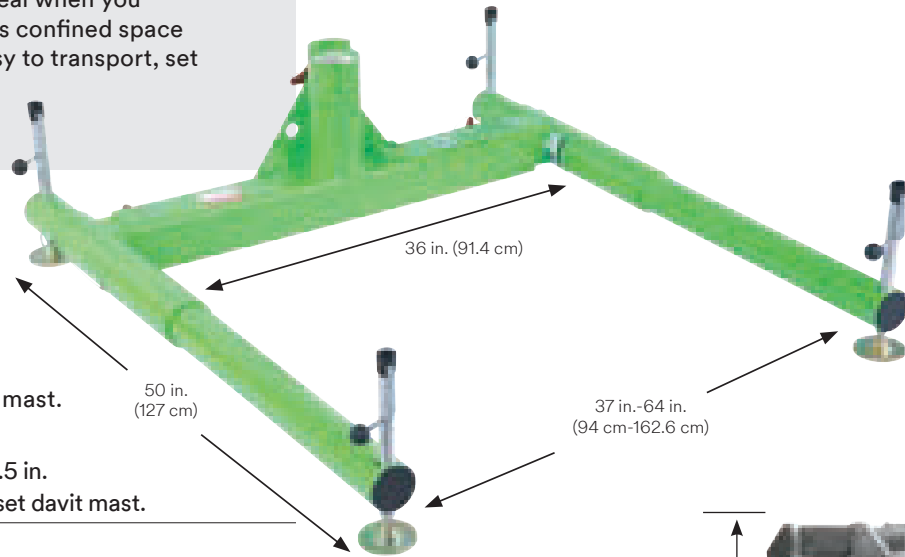

8513565

Carrying Bag

Bag with protective plastic liner for 3-Piece Davit Base (8518005).



8510323

Barrel Mount Sleeve with 3.5 in. Opening

Mild steel construction. Eight independent clamping screws allow temporary installations over edges of shoring cans, walls and other structures. Comes with PVC inner liner. Custom fit openings available.

8510429 Barrel Mount Sleeve with 3 in. (76.2 mm) opening, stainless steel.

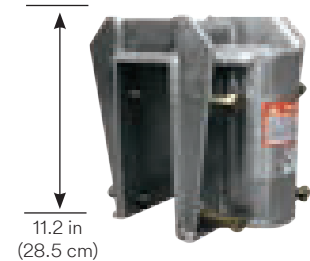

8510568

Forklift Basket

Designed to convert your forklift into a versatile confined space and fall arrest work platform. Add a davit mast and winch/Self-Retracting Lifeline to the basket and you're ready to go. Lightweight aluminum construction and tool-free assembly simplifies setup, transport and storage. Durable powder coated finish with anti-slip finish on walking surfaces. Includes spring-loaded gate. Weight: 215 lbs. (98 kg)

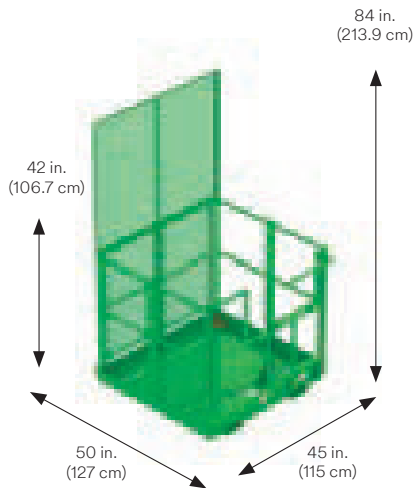

8512285

Adjustable Barrel Mount Sleeve

Designed for shoring, wall and parapet applications. Standard unit accommodates wall thicknesses up to a maximum of 24 in. (60.9 cm), with shorter or longer adjustment tubes available on request. Anodized, welded aluminum with zinc-plated steel hardware with inner sleeve.

8510715 Adjustable Barrel Mount Sleeve for 0 in.-12 in. opening.

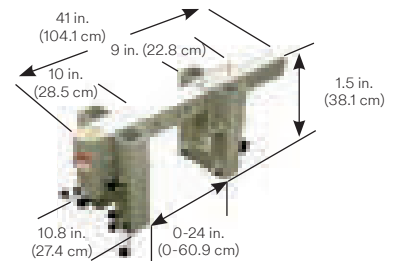

8510501

3M™ DBI-SALA® Manhole Collars

17.5 in. (44.5 cm) Manhole Collar, fits 18 in.-20 in. (45.7 cm-50.8 cm) diameter. Provides a Portable Davit Base by simply fitting within manhole opening. Powder coated aluminum construction with PVC sleeve liner.

8510520 19.5 in. (49.5 cm) Manhole Collar fits 20 in.-22 in. (50.8 cm-55.8 cm) diameter.

8510457 21.5 in. (54.6 cm) Manhole Collar fits 22 in.-24 in. (55.8 cm-60.9 cm) diameter.

8510163 23.5 in. (59.7 cm) Manhole Collar fits 24 in.-26 in. (60.9 cm-66 cm) diameter.

8510633 25.5 in. (64.7 cm) Manhole Collar fits 26 in.-28 in. (66 cm-71.1 cm) diameter.

8510632 27.5 in. (69.8 cm) Manhole Collar fits 28 in.-30 in. (71.1 cm-76.2 cm) diameter.

8510546 29.5 in. (74.9 cm) Manhole Collar fits 30 in.-32 in. (76.2 cm-81.2 cm) diameter.

8512994 33.5 in. (83.1 cm) Manhole Collar fits 34 in.-36 in. (86.3 cm-91.4 cm) diameter.



8510140

Vehicle Hitch Mount Sleeve

Designed to install into a 2 in. (51 mm) hitch receiver on an attendant vehicle to provide a portable anchor point for confined space entry, rescue and fall arrest systems. Assembly for a maximum 27.5 in. (69.8 cm) Offset Davit Mast.

8514461 Assembly for a maximum 42.5 in. (108 cm) Offset Davit Mast.

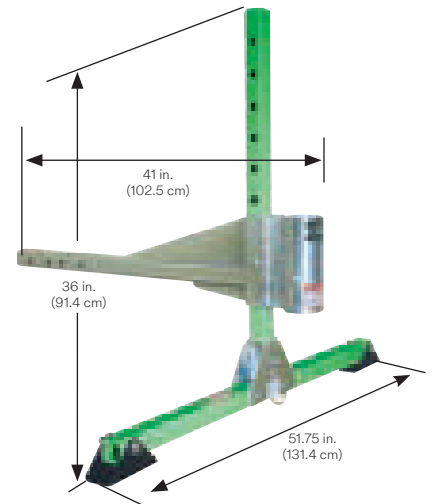

Vehicle Hitch Sleeve Extensions

A maximum of one extension can be used with a hitch mount and a bumper attachment.

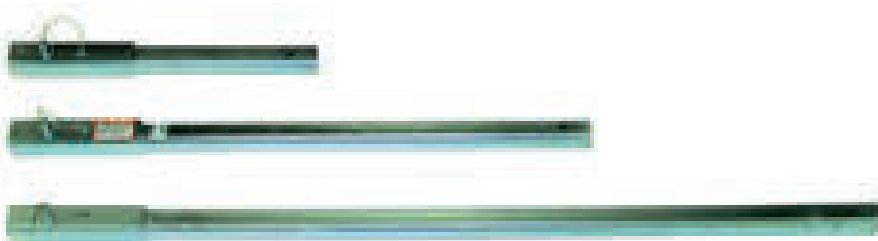

8514503 2 ft. (0.61 m) Vehicle hitch mount sleeve extension. Weight: 17 lbs. (7.7 kg)

8512829 4 ft. (1.21 m) Vehicle hitch mount sleeve extension. Weight: 27.8 lbs. (12.6 kg)

8511384 6 ft. (1.83 m) Vehicle hitch mount sleeve extension. Weight: 39 lbs. (17.6 kg)

8511401

Universal Joint Assembly

Installs between the Hitch Mount Sleeve (8510140) or extension and the vehicle to compensate for uneven ground conditions. Weight: 10 lbs. (4.5 kg)



3M™ DBI-SALA® Counterweight Systems

Counterweight Systems are composed of a central base unit to accommodate a variety of anchoring options, positioning and adjustment legs, and extension assemblies.

8512894

Counterweight System

Counterweight system base with pole leg assembly.
Weight: 199 lbs. (90.2 kg)

Counterweight requirements determined by application.
Contact customer service to order.

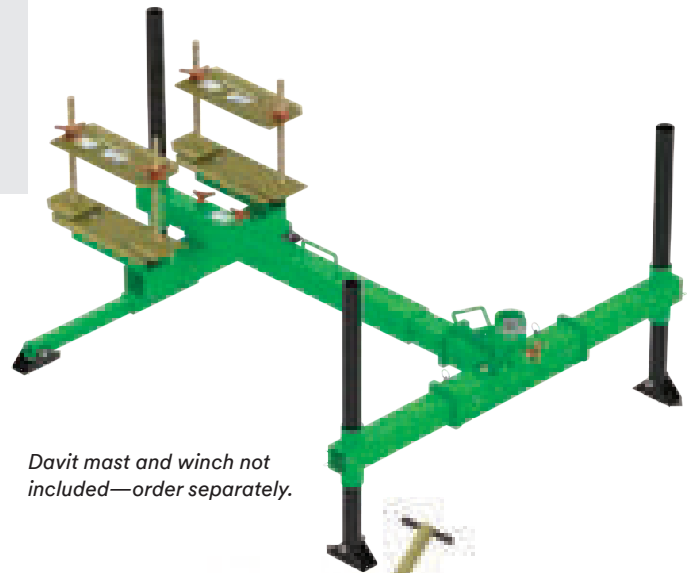

Davit mast and winch not included—order separately.

8520775

Mobile Counterweighted Cart Base

Ideal for areas that require access near a leading edge or into large tanks. System comes complete with counterweight cart, 36 in. (91.4 cm) inner extension tube, center section, and two outrigger screw assemblies. System counterweighted by 50 lb. (22.7 kg) weight plates. (Weight plates, davit mast and winch not included—order separately.)



8530088

Portable Catwalk Clamping Base

Designed to secure to 36 in. (91.4 cm) wide walkways. Ideal for areas that require access off a mezzanine or walkway. System comes complete with catwalk hook, 16 in. (40.6 cm) inner extension tube, center section and two outrigger screw assemblies. Other models available to accommodate different widths of walkways. (Davit mast and winch not included—order separately.)

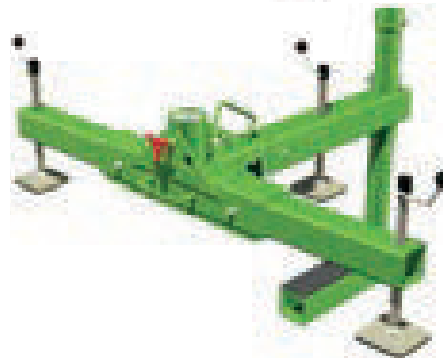

8530256

Portable Anchor Point Base

Ideal for areas that require access over a leading edge. System comes complete with U-bolt anchor point to attach to secondary fixed anchor, 36 in. (91.4 cm) inner extension tube, center section, and two outrigger screw assemblies. System requires a 5,000 lb. (22 kN) anchorage point to be tied down to. (Davit mast and winch not included—order separately.)



3M™ DBI-SALA® Tripods

Constructed of lightweight tubular aluminum with a rugged steel head assembly. Quick-release pins positively locate components at all adjustment points for tool-free setup and adjustment.

1 Mechanical Devices

Supports up to three winches or SRLs for complete flexibility.

2 Quick-Connect Bracket

Fast and easy attachment of mechanical devices.

3 Safety Chain

Added support in demanding applications.

4 Top Mounted Pulley System

Mount up to three pulleys to route mechanical device lifelines.

5 Secondary Anchor Point

5,000 lb. (22 kN) anchor point for secondary fall arrest system.

6 Aluminum Construction

Lightweight and durable for ease-of-use.

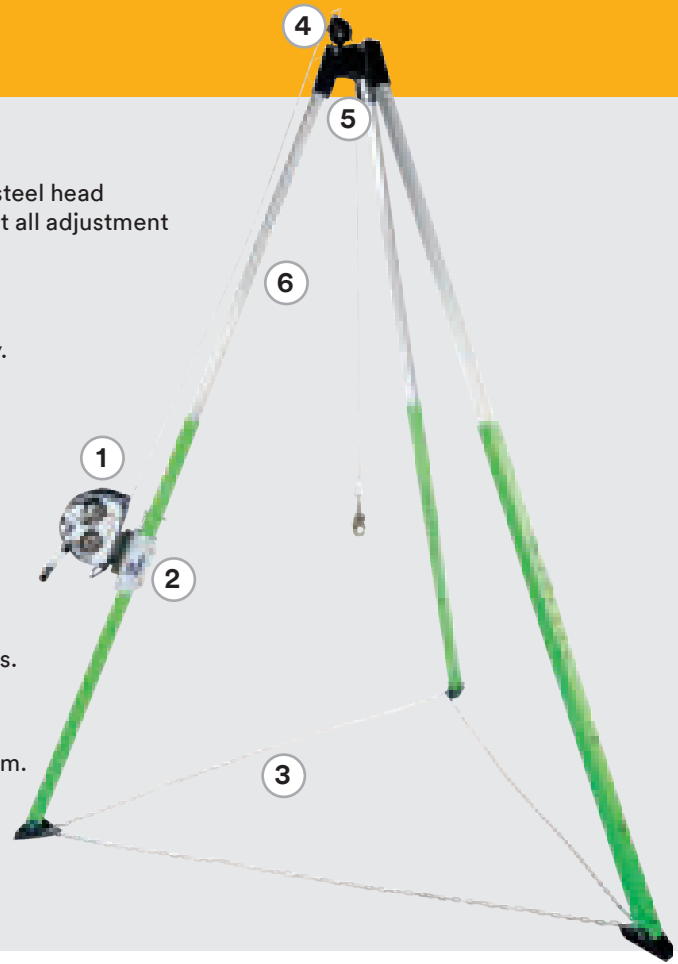

3M™ DBI-SALA® Aluminum Tripod with Salalift™ II Winch

Selection guide:

Part #	Tripod Height	Capacity	Lifeline Type	Lifeline Length	Lifeline
8300030	7 ft. (2.1 m)	350 lbs. (159 kg)	Galvanized Cable	60 ft. (18 m)	1/4 in. (6.3 mm) dia. 7×19 Galvanized Aircraft Wire Rope
8300031	7 ft. (2.1 m)	350 lbs. (159 kg)	Stainless Steel Cable	60 ft. (18 m)	1/4 in. (6.3 mm) dia. 7×19 Stainless Steel Aircraft Wire Rope
8300040	9 ft. (2.7 m)	350 lbs. (159 kg)	Galvanized Cable	60 ft. (18 m)	1/4 in. (6.3 mm) dia. 7×19 Galvanized Aircraft Wire Rope
8300041	9 ft. (2.7 m)	350 lbs. (159 kg)	Stainless Steel Cable	60 ft. (18 m)	1/4 in. (6.3 mm) dia. 7×19 Galvanized Aircraft Wire Rope

3M™ DBI-SALA® Tripod with Salalift™ II Winch & Sealed-Block 3-Way SRL

Selection guide:

Part #	Tripod Height	Tripod Capacity	SRL Capacity	Lifeline Type	Lifeline Length SRL and or winch length	Lifeline
8301041	7 ft. (2.1 m)	350 lbs. (159 kg)	75-310 lbs. (34-141 kg)	Galvanized Cable	Winch: 60 ft. (18 m) SRL: 50 ft.	Winch: 1/4 in. (6.3 mm) dia. 7×19 Galvanized Aircraft Wire Rope SRL: 3/16 in. (5 mm) dia. 7×19 Galvanized Aircraft Wire Rope
8301042	7 ft. (2.1 m)	350 lbs. (159 kg)	75-310 lbs. (34-141 kg)	Stainless Steel Cable	Winch: 60 ft. SRL: 50 ft. (15.2 m)	Winch: 1/4 in. (6.3 mm) dia. 7×19 Stainless Steel Aircraft Wire Rope SRL: 3/16 in. (5 mm) dia. 7×19 Stainless Steel Aircraft Wire Rope
8301043	9 ft. (2.7 m)	350 lbs. (159 kg)	75-310 lbs. (34-141 kg)	Galvanized Cable	Winch: 60 ft. (18 m) SRL: 50 ft.	Winch: 1/4 in. (6.3 mm) dia. 7×19 Galvanized Aircraft Wire Rope SRL: 3/16 in. (5 mm) dia. 7×19 Galvanized Aircraft Wire Rope

3M™ DBI-SALA® Tripod with Sealed-Block 3-Way SRL

Selection guide:

Part #	Tripod Height	Capacity	Lifeline Type	Lifeline Length	Lifeline
8301030	7 ft. (2.1 m)	75-310 lbs. (34-141 kg)	Galvanized Cable	50 ft. (15.2 m)	3/16 in. (5 mm) dia. 7×19 Galvanized Aircraft Wire Rope

3M™ DBI-SALA® Ultra-Lok™ 3-Way Tripod Combo

Selection guide:

Part #	Tripod Height	Capacity	Lifeline Type	Lifeline Length	Lifeline
8301062	7 ft. (2.1 m)	75-310 lbs. (34-141 kg)	Galvanized Cable	50 ft. (15.2 m)	3/16 in. (5 mm) dia. 7×19 Galvanized Aircraft Wire Rope
8301064	9 ft. (2.7 m)	75-310 lbs. (34-141 kg)	Galvanized Cable	50 ft. (15.2 m)	3/16 in. (5 mm) dia. 7×19 Galvanized Aircraft Wire Rope

3M™ DBI-SALA® Ultra-Lok™ 3-Way Tripod Combo with Winch

Selection guide:

Part #	Tripod Height	Tripod Capacity	SRL Capacity	Lifeline Type	Lifeline Length	Lifeline
8301066	7 ft. (2.1 m)	350 lbs. (159 kg)	75-310 lbs. (34-141 kg)	Galvanized Cable	Winch: 60 ft. (18 m) SRL: 50ft (15.2m)	Winch: 1/4 in. (6.3 mm) dia. 7×19 Galvanized Aircraft Wire Rope SRL: 3/16 in. (5 mm) dia. 7×19 Galvanized Aircraft Wire Rope
8301068	9 ft. (2.7 m)	350 lbs. (159 kg)	75-310 lbs. (34-141 kg)	Galvanized Cable	Winch: 60 ft SRL: 50 ft. (15.2 m)	Winch: 1/4 in. (6.3 mm) dia. 7×19 Galvanized Aircraft Wire Rope SRL: 3/16 in. (5 mm) dia. 7×19 Galvanized Aircraft Wire Rope

8513158

3M™ DBI-SALA® UCT-300
7 ft. Tripod

- Lightweight, durable aluminum construction.
- Telescoping adjustable locking legs.
- Built-in pulley system—can accommodate up to three pulleys.
- 5,000 lb. (22 kN) built-in head mounted anchor point.
- Capacity: 450 lbs. (204 kg)

8513159 10 ft. (3 m)

Winch and SRL not included—order separately.



8000010

9 ft. Aluminum Tripod

With adjustable locking legs, safety chains, top pulley and winch bracket. 350 lbs. (159 kg) capacity.

8512292

Winch/SRL Mounting Bracket for Tripod (8513159)

8510224

Winch/SRL Mounting Bracket for Tripod (8513158)

8512293

Top Pulley Assembly for UCT Series Tripods

Routes mechanical device's lifeline over and into confined space area.



8000000

3M™ DBI-SALA® 7 ft. Aluminum Tripod

- Lightweight, durable aluminum construction.
- Telescoping adjustable locking legs.
- Built-in pulley system.
- 5,000 lb. (22 kN) built-in head mounted anchor point.
- Capacity: 350 lbs. (159 kg)

Winch and SRL not included—order separately.



Accessories

8513330

Carrying Bag

For 10 ft. (3 m) Tripod with protective plastic liner (8513159).

8513329 Carrying Bag for 7 ft. (2.1 m) tripod with protective plastic liner (8513158)

9503094 Carrying Bag for 7 ft. (2.1 m) tripod (8000000)

9503095 Carrying Bag for 9 ft. (2.7 m) tripod (8000010)



3M™ DBI-SALA® Pole Hoist System

The pole hoist attaches with a carabiner on the universal bracket to a suitable anchor point, allowing you to work in any direction from any angle. It has a unique swivel head that rotates 360 degrees, providing flexibility in both vertical and horizontal confined space entries. Custom lengths available—call for details.

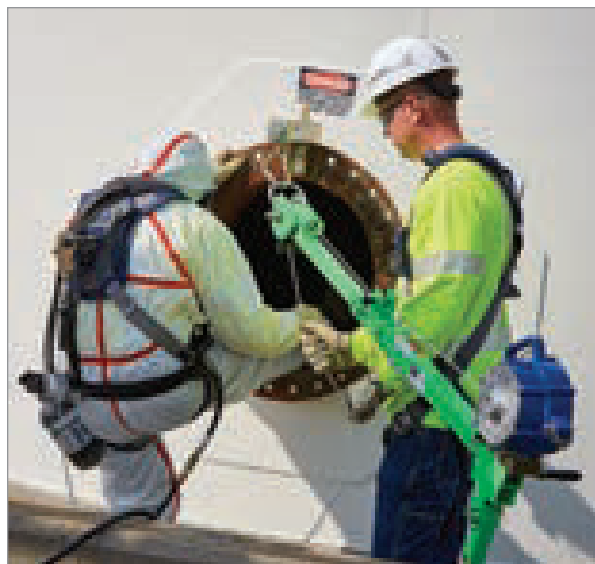

8530253

Extendable Pole Hoist 6 ft.-10 ft.
(1.8 m-3 m)

Extension with swivel head and winch mounting bracket, T-bar leg assembly and hardware/fasteners. Weight: 14 lbs. (6.4 kg)

8530252 Extendable Pole Hoist
4 ft.-7 ft. (1.2 m-2.1 m)
Weight: 12 lbs. (5.4 kg)

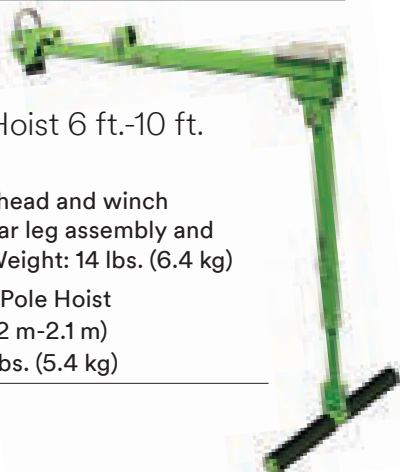

Accessories

8520777

Clamp-On Anchor
for Pole Hoists

Designed to secure to a vertical or horizontal flange up to 6 in. (15.2 cm) thick and provide an anchorage point to connect a pole hoist device to.



2104550

Steel Anchor Plate
with D-Ring

This plate anchor offers a compact, reliable attachment to 3/8 in.-1 in. thick plate steel for connecting your lanyard, vertical lifeline system or self-retracting lifeline.

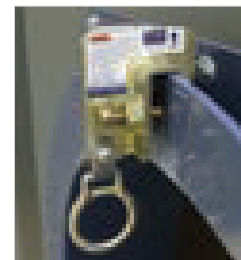

8513330

Carrying Bag

For 6 ft.-10 ft. pole hoist.

8513329 Carrying Bag for
4 ft.-7 ft. pole hoist.

3M™ DBI-SALA® Portable Fall Arrest Posts

Our portable fall arrest post allows for up to three workers on top of transformers or other types of vertical platforms with potential fall hazards.

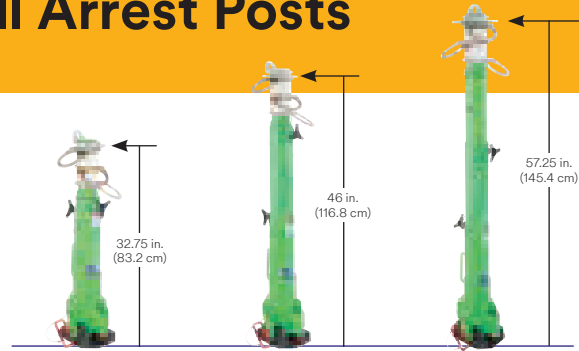

Telescoping design: Overall height can be adjusted from 32.75 in.-57.25 in.

8516691

Portable Fall Arrest Post

- Three independent swiveling tie-off points.
- 360 degrees of protection for three workers.
- Telescopic design; 32.75 in.-46 in.-57.25 in. (83.2 cm-116.8 cm-145.4 cm)
- Lightweight and durable aluminum construction.



8516693

Rescue Davit Arm for Portable Fall Arrest Post

The optional rescue davit arm assembles easily to our portable fall arrest post, providing simple and efficient rescue and material handling capabilities.

8516691 post not included—order separately.



Anchor Bases for Portable Fall Arrest Post

8517412

Bare Steel Uni-Anchor with Tie-Off Anchors

For closed environments without chemical or moisture exposure.



8510816

Weld-On Mounting Plate

Unplated mild steel construction.



8517413

Incline Adapter with Tie-Off Anchor

Permanently weld to inclined surfaces.



8519819

Base Concrete Anchor.

Bolt-on anchor plate for concrete or steel surfaces.



Accessories

8516692

14 in. Anchor Post Extension

Provides option to tie-off one worker at an increased height of 68.5 in. (174 cm). Weight: 5 lbs. (2.2 kg)



8517565

Carrying Bag

Heavy-duty carrying bag for Portable Fall Arrest Post.



3M™ DBI-SALA® Mechanical Systems

Retrieving incapacitated workers and bringing them to safety makes the mechanical device one of the most critical parts of your rescue system. In some situations, you may need a secondary or backup system.

1 Digital Winches

- Man rated 450 lb. (201 kg) capacity.
- Digital usage indicator tracks drum revolutions to determine service intervals.
- Triple redundant braking system.
- Sealed bearings at all contact points.

2 3-Way Sealed-Block Self-Retracting Lifeline

- Ideal for secondary or backup.
- Man rated 420 lb. (190 kg) capacity.
- Fall arrest system limits forces to 900 lbs. (4 kN)
- Built-in emergency retrieval winch.
- Input handle with primary brake.

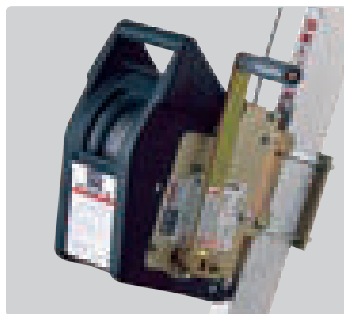

3M™ DBI-SALA® Salalift™ II Winches

- Man rated 350 lb. (159 kg) capacity.
- Overload clutch.
- Gear ratio of 6:1.
- Free-wheel mode.
- Shielded ball bearings.



3M™ DBI-SALA® Winches

Drive type	Lifeline type	Mounting bracket	Winch bag	Digital winch	Salalift™ II Winch	50 ft. (15.2 m)	60 ft. (18 m)	90 ft. (27 m)	120 ft. (36.5 m)	140 ft. (42 m)	190 ft. (58 m)	240 ft. (73 m)	290 ft. (88 m)
Power drive*	Galvanized steel	■	-	■	-	-	8518567	8518568	-	8518588	8518589	8518610	8518611
	Stainless steel	■	-	■	-	-	8518565	8518566	-	8518586	8518587	8518608	8518609
	Technora® rope	■	-	■	-	-	8518571	-	-	-	-	-	-
Removable handle	Galvanized steel	■	-	■	-	-	8518560	8518561	-	8518581	8518582	8518603	8518604
		■	■		■	-	8102001	8102009	8102005	-	-	-	-
	Stainless steel	■	-	■	-	-	8518558	8518559	-	8518579	8518580	8518601	8518602
		■	■		■	-	8102003	8102011	8102007	-	-	-	-
	Technora® rope	■	-	■	-	-	8518564	-	-	-	-	-	-
		■	■	-	■	8102050	-	-	-	-	-	-	-
		Cable model weight				-	30.5 lbs. (13.8 kg)	32.5 lbs. (14.7 kg)	38.5 lbs. (17.5 kg)	40 lbs. (18.4 kg)	43 lbs. (19.5 kg)	50 lbs. (22.6 kg)	53.5 lbs. (19.5 kg)
		Technora® rope model weight				27 lbs. (12.2 kg)	27 lbs. (12.2 kg)	-	-	-	-	-	-

The 3M™ DBI-SALA® Salalift™ II Winch includes a mounting bracket and carrying bag.

* Power drive units require Overload Protection Clutch (8512936)—not included.



Digital Winch



Salalift™ II Winch

8512936

Overload Protection Clutch

Features a maximum working load of 450 lbs.



3M™ DBI-SALA® 3-Way Self-Retracting Lifelines



3-Way Sealed-Block SRL - RSQ



3-Way Ultra-Lok™ SRL



3-Way Sealed-Block SRL

Cable type	Sealed-Block	Sealed-Block without bracket	Sealed-Block/RSQ	Ultra-Lok	30 ft. (9.1 m)	50 ft. (15.2 m)	85 ft. (25.9 m)	130 ft. (39.6 m)	175 ft. (52.5 m)
Galvanized steel	■	-	-	-	3400853	3400923	3400871	3400976	-
	-	■	-	-	3400850	3400920	3400870	3400975	3400660
	-	-	■	-	-	3400940	3400910	3401002	-
	-	-	-	■	-	3501102	-	-	-
Stainless steel	■	-	-	-	3400858	3400926	3400882	3400987	-
	-	■	-	-	3400852	3400922	3400874	3400979	3400661
	-	-	■	-	-	3400942	3400912	3401004	-
	-	-	-	■	-	3501103	-	-	-

8510207

Winch/SRL Adapter with Flat Back

Attaches 3M™ DBI-SALA® Winch/SRL to structures.



8516824

Quick-Release Mounting Bracket

For upper and lower masts.



8517567

Padded Carrying Bag

For digital winch.



1001210

Retrieval Wristlets

For upper and lower masts. Rescue/retrieval design is ideal for connection to victim's wrists for narrow extractions. D-ring at end x 2 ft. (0.6 m).

1001220 Attached with an O-ring at one end x 18 in. (0.46 m)



1231460

Y-Lanyard

Rescue/retrieval design ideal for use with harness incorporating D-rings. D-ring at center x 2 ft. (0.6 m).

1231470 Y-Lanyard without spreader bar x 2 ft. (0.6 m)



Always be rescue-ready.

Rescue and Descent

Make the 3M™ DBI-SALA® Self-Rescue Device your rescue plan. It attaches to your safety harness and allows you to lower yourself to safety in the event of a fall from height. It helps minimize the risk for you, your coworkers and emergency response personnel.



Choosing a rescue and descent system.

A single rescue system cannot efficiently handle every scenario and may perform well for one application but not another. When choosing a system, it's important to consider the job site, anchor location, working load and ease-of-use.

3M™ DBI-SALA® Self-Rescue Device

Work at height without worrying about hanging in your harness for an extended period of time after an arrested fall event. Instead of waiting for help, lower yourself to safety with the 3M™ DBI-SALA® Self-Rescue Device.

1 Easily Accessible Primary Release Cord

2 Easy-Link SRL Adapter

A simple, fast connection point for your lanyards or personal SRLs.

3 Molded Padding

Protects the bag from wear and tear.

4 Color-Coded and Reflective Elements

Provides greater visibility, even in dark situations.

5 Assisted-Rescue and 3M™ DBI-SALA® Rescue Pole

Allows for remote access and deployment by a colleague.

6 50- and 100-Foot Lengths

More flexibility and freedom to work at height worry-free.



Virtually Universal Attachment

The Self-Rescue Device retrofits to virtually any safety harness, so you can keep wearing the one you're most comfortable using.

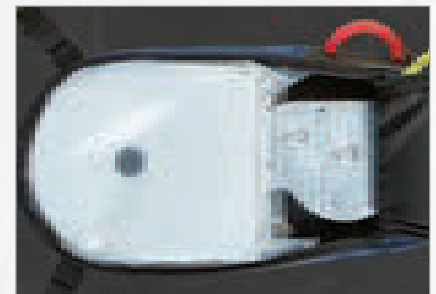

Sealed Descent Device and Rope Spool

Designed and tested to withstand the toughest conditions.



3320031
Self-Rescue 100

Height: 19 in., Width: 7 in.
Depth: 2.5 in., 100 ft. of 5.5 mm rope.

3320030
Self-Rescue 50

Height: 19 in., Width: 7 in.
Depth: 2.5 in., 50 ft. of 5.5 mm rope.



Lightweight,
low profile
design
minimizes
impact on
user's motion.
Unit width: 7 in.



3320037
Self-Rescue Training Device

This 30-foot trainer device simulates a realistic fall rescue experience, allowing you to educate your team on the use of the product. It's easy to rewind the rope on-site, so you can train your team up to 20 times before recertification of the device will be required.

Height: 19 in., Width: 7 in.
Depth: 2.5 in., 30 ft. of 5.5 mm rope.

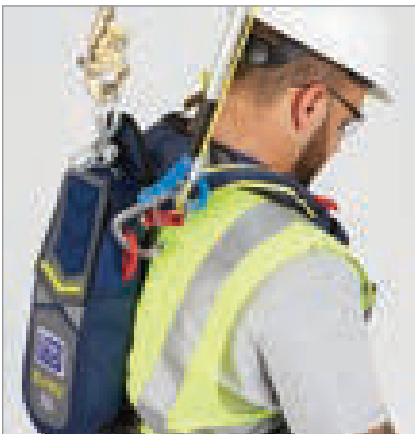

8900299
Rescue Pole

Kit includes bag, rescue pole, carabiner and tagline.

Bag length: 28.5 in.
Width: 6 in.
Depth: 2 in.
Weight: 2 lbs.
Pole extends to 8 ft. 8 in.



3M™ DBI-SALA® Dual-Mode Descent

Work and rescue with the same equipment for lower cost of ownership—without compromising safety.

- Standard fall arrest mode.
- Remote/assisted descent activation options.
- Automatic descent mode.
- As featured on Sealed-Block RSQ and Ultra-Lok™ RSQ Self-Retracting Lifelines.



Fall arrest mode
Assisted rescue
by pole



Fall arrest mode
Assisted rescue
by hand

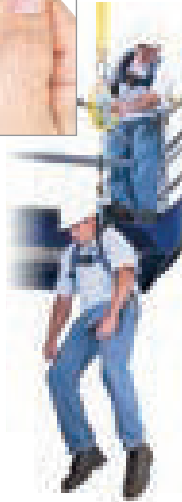

*These assisted rescue options
“engage” the descent mode.
Traditional assisted rescue
operations may also be conducted.*



Automatic descent mode
Self-rescue/descent



3400930

Sealed-Block RSQ Self-Retracting Lifelines

Stainless steel wire rope with swivel snap hook, RSQ dual-mode, anchorage carabiner, 4 ft. (1.2 m) cable tie-off adapter.

3400932

50 ft. (15 m)

3400886

85 ft. (25.5 m)

3400991

130 ft. (39 m)



3504550

Ultra-Lok™ RSQ Self-Retracting Lifelines

50 ft. (15.2 m) of 3/16 in. (5 mm) wire rope with swivel snap hook and RSQ dual-mode.

3504550

Galvanized Steel Wire Rope

3504552

Stainless Steel Wire Rope

D Rescue and Descent

3M™ DBI-SALA® Rollgliss™ R550 Rescue and Descent

Keep rescues simple with one of the lightest, most compact and easy-to-use devices in the industry.

1 Drill Adapter

Provides a mechanical option to raise a victim.

2 Cast Aluminum Housing

Lightweight and extremely durable.

3 Bi-Directional Hub

Brings one hook up as the other goes down, for immediate use after each descent.

4 Anchorage

Provides greater visibility, even in dark situations.

5 Integrated Rope Ears

Greater descent speed control in assisted rescues.

6 Dual Brakes

Added security, safety and peace of mind.

7 Durable Rope

3/8 in (9.5 mm) Static Kernmantle Rope.

8 Lifeline Hook

Patented Self-Locking Snap Hook.



Drill adapter

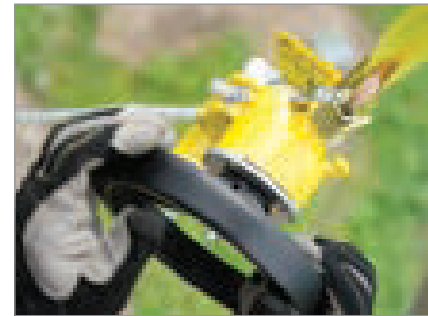

Super-tough nylon makes the rescue wheel lightweight and durable. The ergonomic design provides a better grip and more control.

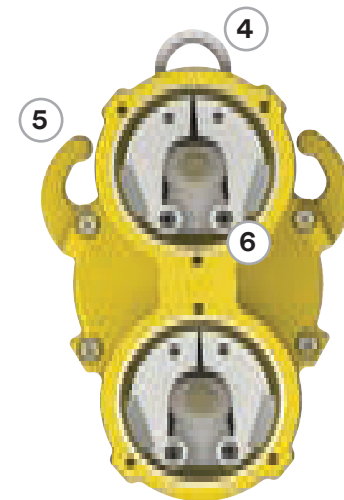

Multiple Length Options

Lengths between 50 ft. (15 m) and 500 ft. (152 m)

Two-Person Capacity

Can be used from heights up to 1,640 ft. (500 m) for one user at 310 lbs. (141 kg) or 575 ft. (175 m) for two users totaling 620 lbs. (282 kg)

Optional Ladder Bracket

Sold separately—3320014.

3M™ DBI-SALA® Rollgliss™

R550 Rescue Units

Includes carabiner (two), 4 ft. (1.22 m) anchor sling and rope bag.

Selection guide:

Part #	Length
3327050	50 ft. (16 m)
3327100	100 ft. (31 m)
3327150	150 ft. (46 m)
3327200	200 ft. (61 m)
3327275	275 ft. (84 m)
3327300	300 ft. (92 m)
3327325	325 ft. (100 m)
3327350	350 ft. (107 m)
3327400	400 ft. (122 m)
3327450	450 ft. (137 m)
3327500	500 ft. (153 m)



3M™ DBI-SALA® Rollgliss™

R550 Escape Units

Includes carabiner (two), 4 ft. (1.22 m) anchor sling.

Selection guide:

Part #	Length
3325100	100 ft. (31 m)
3325200	200 ft. (61 m)
3325275	275 ft. (84 m)
3325300	300 ft. (92 m)
3325400	400 ft. (122 m)
3325500	500 ft. (152 m)



3M™ DBI-SALA® Rollgliss™

R550 Rescue Units with Case

Includes edge protector, 4 ft. (1.22 m) anchor sling (two), 2.5 ft. (0.76 m) anchor sling, pulley, rope grab, carabiner (three), rope bag and humidity case.

Selection guide:

Part #	Length
3326100	100 ft. (31 m)
3326300	300 ft. (92 m)
3326350	350 ft. (107 m)



9508289

Accessories

9506162

Rope Bag

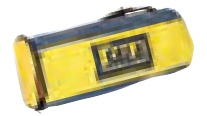

3620005

Anchoring Sling

4 ft. (1.22 m)



3620004

Anchoring Sling

2.5 ft. (0.76 m)

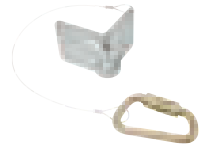

3320003

Edge Protector with Carabiner

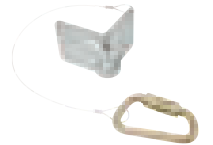

9504733

Pulley

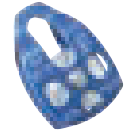

8900298

Rescue Pole



3320014

Ladder Bracket



9508289

Humidity Case

Fully sealed case provides 10 year minimum storage life. External humidity indicator allows user to inspect the seal without opening case.



2000112

Carabiner

1 1/16 in. (1.75 cm) gate.



2000114

Carabiner

2 3/16 in. (5.56 cm) gate.



D

Rescue and Descent

3M™ DBI-SALA® Rollgliss™ R350 Rescue and Descent Positioning Device

Get efficient hauling and very controlled lowering—using a finger and thumb to hold a load.

8902004

Rollgliss™ R350
Rescue System

50 ft. travel/200 ft. of 3/8 in. rope (15.2 m/61 m), 3:1 ratio with pulleys, rope control device, anchor strap, carabiner and carrying bag.



8902006

Rollgliss™ R350
Rescue System

100 ft. travel/400 ft. of 3/8 in. rope (30.5 m/122 m), 3:1 ratio with pulleys, rope control device, anchor strap, carabiner and carrying bag.

Other lengths available in 10 ft. (3 m) increments. Accessories including 2:1, 4:1 and 5:1 pulleys are available.

Rollgliss™ Rescue Positioning Device

Service buildings, bridges and dams with this versatile rescue positioning device. It features a speed-sensing lock that allows you to manually lock off the device once you reach a work level. It serves both as a rescue system and has features for raising, lowering and positioning during normal work activities.

- Pre-rigged for quick and easy installation and use.
- No special tools, power source or extensive skills needed.
- Built-in brake.
- Lock-out mechanism allows user to stop/start anywhere.

3602050

Rollgliss™ Rescue Positioning Device

50 ft. travel/260 ft. of 3/8 in. rope (15.25 m/79.3 m), 4:1 ratio with pulleys, rope anchor straps, two carabiners and carrying bag.

3602100

Rollgliss™ Rescue Positioning Device

100 ft. travel/510 ft. of 3/8 in. rope (30.5 m/155.5 m), 4:1 ratio with pulleys, rope anchor straps, two carabiners and carrying bag.

3M™ DBI-SALA® Rollgliss™ Descender

Make a quick and safe escape. Either vertical or sloped descent models are available to provide complete versatility and flexibility for any job site or work environment.



		Descent type	Lifeline material	Low or high speed	115 ft. (35 m)	200 ft. (61 m)
Vertical	Galv		Low	3303000	-	
			Low	-	3303017	
	SS		Low	3303002	-	
			Low	-	3303018	
Sloped	Galv		Low	3303001	3303021	
			High	-	3303015	
	SS		Low	3303003	3303019	
			High	-	3303016	

Sloped low speed models also include linkage, guide cable sleeve and suspension bars. Sloped high speed models include linkage, braking trolley and suspension bars.

8900292

Rollgliss™ R250 Rescue Kit

Enables the rescuer to remove a person from danger without putting themselves at risk by descending to them.

- 33 ft. (10 m) travel length.
- Easily transported in backpack-style bags.
- Takes only a few minutes to set up and use.



8900293 Rollgliss™ Rescue Kit with 66 ft. (20 m) travel length.

8900294 Rollgliss™ Rescue Kit with 99 ft. (30 m) travel length.

3601490

Rollgliss™ Sealed Tension Limiter

Attaches to man-riding system in-line between the person and the raising/lowering line to warn operator and limit forces on an entangled worker.

- Limits loading on person to 400 lbs. (182 kg) to prevent severe injury.
- High visibility line.
- Portable and lightweight.

Always use a separate back-up fall protection device with this system.



8516294

Rollgliss™ Rescue Ladder

Provides a way to assist rescue after a fall has occurred. It can be anchored to a structure and dropped to the victim, so they can climb up or down to safety.

- Available in 8 ft. (2.4 m) sections.
- Extra sections can be added.
- Includes three carabiners for attachment.



8516316

Rollgliss™ Rescue Ladder Anchor

For mounting rescue ladder to a davit arm or single anchorage point.



Technical Rescue Lines

This line complements our line of industrial rescue systems, including pre-rigged rescue kits like the Rollgliss™ R350, R550 and more.

Descenders

8700388

Double Stop Descender Range

Anodized gold/blue aluminum, suits 12.5-13 mm rope.

8700387 Anodized gold aluminum, suits 10.5-12mm rope.



2103189

Fisk Descender

- Gentle flow for 19 in. (48.3 cm) of lifeline to pass through the descender.
- Large radius for smoother descent and less wear to lifeline.
- Reduction in rope hockling and torsional twist.
- Durable 304 stainless steel construction.

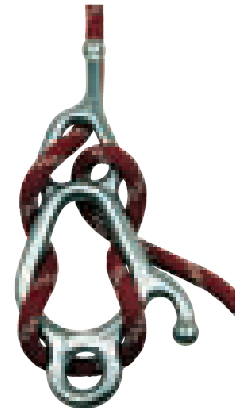

Netting and Guardrails

Grab the right netting or guardrail. It'll return the favor.

3M™ DBI-SALA® Netting and Guardrail Systems are extremely simple to set up and offer a variety of configurations for accommodating your needs. We manufacture portable and permanent systems for various applications and customize solutions to meet specific jobsite requirements. All of our systems meet or exceed OSHA and ANSI standards.



Choose a netting system.

Look for quality in these features when selecting netting.

1 Quality material

3M™ DBI-SALA® Netting is rot-proof, mildew-proof and has UV protection for longer lasting service.

2 Adjustability

Our 3M™ DBI-SALA® Adjust-A-Net™ System is the only personnel net that can be adjusted to fit the work area.

3 Mesh sizes and liners

Meshes are available in many sizes and strengths, depending on the job.

4 Anchoring points and ease of installation

Our netting systems are available with the related cable and hardware for installation to steel or concrete and are lightweight, so they're easy to handle for fast and safe installation.

5 Snap hooks

Featuring a staggered system of lashed-in snap hooks, our netting systems allow for quick and easy connections.

Can't find the right configuration? Contact your 3M Fall Protection sales representative.

Personnel/Debris Nets

3M™ DBI-SALA® Border Guard™ System

This exclusive system is the first lightweight personnel/debris system made for rigging nets around perimeters of new concrete buildings. It allows single floor attachment for closer protection at the pour level.

- Meets ANSI and OSHA standards for debris containment and for falls by personnel of 10 ft. or less.
- Installs from one level without a crane or special equipment.
- Non-destructive floor clamps easily attach to concrete slabs.

3M™ DBI-SALA® Border Guard™ System

Conveniently and economically enhance confidence and productivity at your building site. This exclusive system is the first lightweight debris/personnel system made for rigging nets around the perimeter of new concrete buildings. It allows single floor attachment for closer protection at the pour level. Unlike alternative systems, it comes in convenient units and installs with sturdy hardware that's half the weight of the old style net systems.

- Meets ANSI and OSHA standards for debris containment and for falls by personnel of 10 ft. or less.
- Easily installed, from one level without a crane or special equipment.
- Non-destructive floor clamps easily attach to concrete slabs.
- Nets extend 10 ft. (3 m) out from floor edge.

Border Guard™ Starter Kit

1 ea. net, 4 in. black mesh with 1/8 in. debris liner and snap hooks, 2 ea. floor clamps, 2 ea. 10 ft. arms, 2 ea. 1/2 in. shackles, 8 ea. bolts, 6 ea. cable assemblies, 2 ea. straps with cam buckles.

Also available are starter kits with column bases. 2 arms, 2 concrete/I-beam column clamps, net and hardware.

4100047 Starter Kit, 10 ft. x 25 ft., column base.

4100155 Starter Kit, 10 ft. x 30 ft., column base.

10 ft. x 10 ft.	10 ft. x 15 ft.	10 ft. x 25 ft.	15 ft. x 30 ft.
4100089	4100091	4100006	4100151

4100005

Border Guard™ Corner Kit

1 ea. 12 ft. x 12 ft. x 17 ft. net, 4 in. black mesh with 1/8 in., debris liner and snap hooks, 1 ea. cable assembly.

4100157 Hardware Pack

Border Guard™ Add-On Kit

1 ea. net, 4 in. black mesh with 1/8 in. debris liner and snap hooks, 2 ea. floor clamps, 1 ea. 10 ft. arm, 1 ea. 1/2 in. shackle, 4 ea. bolts, 3 ea. cable assemblies, 1 ea. strap with cam buckle.

Also available are Add-On Kits with column bases. 1 arm, 1 concrete/I-beam column clamp, net and hardware.

4100141 Add-On Kit, 10 ft. x 10 ft., column base.

4100140 Add-On Kit, 10 ft. x 15 ft., column base.

4100139 Add-On Kit, 10 ft. x 25 ft., column base.

4100156 Add-On Kit, 10 ft. x 30 ft., column base.

10 ft. x 10 ft.	10 ft. x 15 ft.	10 ft. x 25 ft.	10 ft. x 30 ft.
4100092	4100093	4100007	4100153



Border Guard Stanchion

Personnel Nets

Personnel nets are designed to catch workers in unprotected areas such as bridges, buildings, towers, dams, silos, atriums, shafts, stairwells and skylights.

3M™ DBI-SALA® Adjust-A-Net™ with optional debris liner

Four basic models fit any size or shape workspace. Nets must be erected so that workers can never fall more than 25 ft.

- Adjustable straps allow 50% reduction of original size.
- Built-in test cords allow evaluation of integrity.
- Rugged steel snap hooks placed every 48 in. column base

Size	10 ft. x 5 ft.	10 ft. x 10 ft.	10 ft. x 15 ft.	15 ft. x 30 ft.	20 ft. x 40 ft.	25 ft. x 50 ft.	30 ft. x 60 ft.
No debris liner	-	-	-	4100100	4100101	4100102	4100103
Debris liner	4100406	4100405	4100404	4100400	4100401	4100402	4100403



4102003

Flying Form Net

Made for today's multi-story buildings that use flying forms to construct concrete floors.

- One-time installation.
- Passive fall arrest and debris retention.
- UV-protected nylon mesh.



4102002

Pour-in-Place Net

8 ft. x 100 ft. Provides personnel fall protection on unprotected floor openings. Custom sizes are available.

- Passive fall arrest and debris retention.
- Durable nylon mesh.
- Fast and easy removal.

4102001 Pour-in-Place Net, 8 ft. x 50 ft.

Debris Nets

Debris nets catch construction tools and debris and prevent injury to workers, pedestrians, structures and materials below.

3M™ DBI-SALA® Vertical Debris Net

Highly visible, bright orange mesh protects workers near building edges as a guardrail and replaces mid-rail and tow boards, making it less expensive and easier to install.

- UV-resistant, fire-retardant.
- Exceeds OSHA’s 200 lb. strength requirements and New York City construction codes.

4100003 Attachment Kit, 50 clips & 20 tie-down plates.

4100275 Cable ties, 20 in. nylon, 250 lbs., 25-pack.

Net color	Attachment kit	48 in. x 100 ft.	48 in. x 150 ft.	60 in. x 100 ft.
Orange	-	4100200	4100202	4100201
	■	4100300	-	4100301
Blue	-	4100204	-	4100205
	■	4100304	-	4100305



4102000

Floor-to-Ceiling Debris Net

Provides complete containment of project debris and is strong enough to meet guardrail requirements for personnel. Easily connects to top and bottom cables and is reusable throughout the life of the project. 9 ft. 6 in. tall x 30 ft. wide.

4195436 Floor-to-Ceiling Fastener Plates, 16-pack.

Custom sizing available—please call 800-326-6146.



Adjustable Nets

3M™ DBI-SALA® Rack Guard Adjustable Nets

Gray, fire-retardant with borders.

Model #480 — 4 in. x 4 in. mesh — 4,000 lb. load rating

	9 ft. 4 in.	12 ft. 4 in.	16 ft. 4 in.	18 ft. 4 in.	20 ft. 8 in.	25 ft.	27 ft. 8 in.	30 ft. 8 in.
12 ft.	4101575	4101578	4101562	4101565	4101569	4101580	4101571	4101574
16 ft.	4101576	4101581	4101563	4101566	4101583	4101584	4101572	4101623
20 ft.	4101577	4101582	4101564	4101567	4101585	4101586	4101573	-
25 ft.	-	-	-	-	-	4101568	-	-

Model #245 — 2 in. x 2 in. mesh — 2,500 lb. load rating

	9 ft. 4 in.	12 ft. 4 in.	16 ft. 4 in.	18 ft. 4 in.	20 ft. 8 in.	25 ft.	27 ft. 8 in.	30 ft. 8 in.
12 ft.	4101550	4101553	4101587	4101590	4101554	4101555	4101596	4101599
16 ft.	4101551	4101556	4101588	4101591	4101558	4101559	4101597	4101621
20 ft.	4101552	4101557	4101589	4101592	4101560	4101561	4101598	4101622
25 ft.	-	-	-	-	-	4101593	-	-
30 ft.	-	-	-	-	-	4101594	-	-

Rack Hardware Kits

4101502 Flush Mount/Starter Kit (60 ft.) 1/4 in. wire cable, (4) 3/8 in. eyebolts, (8) 1/4 in. cable clamps, (4) 1/4 in. thimbles, (50) 5/16 in. snap hooks, (2-packs) 20 in. ties, (4) flush clamps.

4101500 Flush Mount/Add-On Kit (60 ft.) 1/4 in. wire cable, (4) 3/8 in. eyebolts, (8) 1/4 in. cable clamps, (4) 1/4 in. thimbles, (50) 5/16 in. snap hooks, (2-packs) 20 in. ties, (2) flush clamps.

4101506 Offset Mount/Starter Kit (115 ft.) 1/4 in. wire cable, (8) 3/8 in. eyebolts, (16) 1/4 in. cable clamps, (8) 1/4 in. thimbles, (100) 5/16 in. snap hooks, (1-pack) 20 in. ties, (4) offset clamps.

4101505 Offset Mount/Add-On Kit (115 ft.) 1/4 in. wire cable, (8) 3/8 in. eyebolts, (16) 1/4 in. cable clamps, (8) 1/4 in. thimbles, (100) 5/16 in. snap hooks, (1-pack) 20 in. ties, (2) offset clamps.

4101503 Extension Starter Kit — flush (2) extensions, (2) diagonal braces, (2) flush clamps, (2) backstay braces.

4101501 Extension Add-On Kit (1) extension, (1) backstay brace.

4101504 Extension Starter Kit — offset (2) extensions, (2) diagonal braces, (2) offset clamps, (2) backstay braces.



3M™ DBI-SALA® Conveyor Adjustable Nets

Black, fire-retardant with borders.

Model #130 — 1 in. x 1 in. mesh — 1,000 lb. load rating

9 ft. x 25 ft.	9 ft. x 50 ft.	3 ft. x 25 ft.	3 ft. x 50 ft.
4100016	4100015	4100018	4100017

Conveyor Hardware Kits

4100020 Box Shaped Guard Kit (25 ft. or 50 ft. run) (220 ft.) 1/4 in. wire cable, (8) 3/8 in. eyebolts, (4) 3/8 in. turnbuckles, (8) 1/4 in. thimbles, (16) 1/4 in. cable clamps, (100) 5/16 in. snap hooks, (1-pack) 9 in. ties.

4100019 Side Guard Kit (25 ft. or 50 ft. run) (110 ft.) 1/4 in. wire cable, (4) 3/8 in. eyebolts, (2) 3/8 in. turnbuckles, (2) 1/4 in. thimbles, (8) 1/4 in. cable clamps, (100) 5/16 in. snap hooks, (1-pack) 9 in. ties.

4195161 Optional J-Guide for 5/8 in. or 1/2 in. threaded rod.



Portable Guardrail System

This system acts as a barrier, preventing personnel from falling to lower levels, thus eliminating the fall hazard. This system can protect employees with little or no training, special maintenance or gear.

3M™ DBI-SALA® Portable Guardrail System

- Free-standing system eliminates surface penetration.
- Built-in rail and toe board receptacles allow for infinite configurations.
- Rubber pad provides skid resistance and protects the roof surface.
- Ergonomic handles allow for easy transportation and setup.
- Fast and easy set-screw installation, insert rail and tighten.
- Corrosion-resistant construction for longevity.

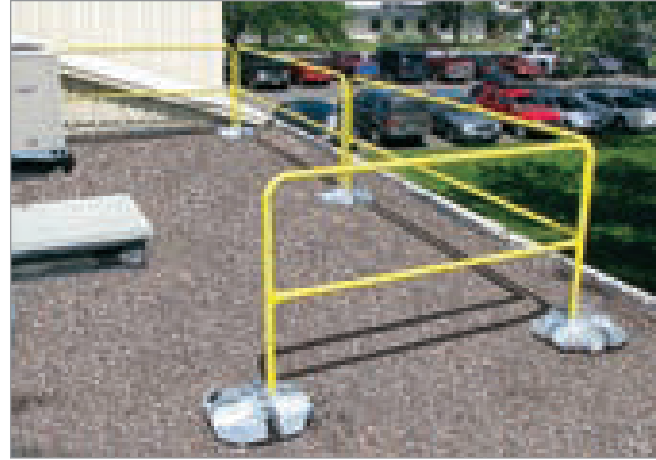

Custom colors available upon request.

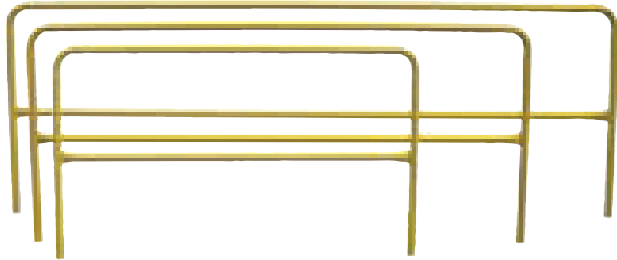

7900061

Guardrail

6 ft. Guardrail Section, steel, powder coated.

8 ft. Guardrail	10 ft. Guardrail	6 ft. Guardrail Galvanized	8 ft. Guardrail Galvanized	10 ft. Guardrail Galvanized
7900062	7900063	7900067	7900069	7900068

7900060

Guardrail Base

Galvanized Base assembly for guardrail system, 70 lbs.

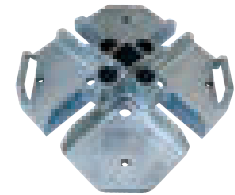

7900005

Guardrail Splice Kit

Powder coated steel splice kit allows user to connect customized shortened rail sections together.



7900007

Guardrail Gate

Powder coated steel swing gate, adjustable from 23 in.-38 in.



7900100

3M™ DBI-SALA® Portable Construction Guardrail Stanchion

This system acts as a barrier, preventing personnel from falling to lower levels, thus eliminating the fall hazard. This system can protect employees with little or no training, special maintenance or gear.

- Mounts in both parapet and edge grab configurations for jobsite versatility.
- Rapid clamping system expands from 6 in.-24 in. (15.25 cm-61 cm)
- Durable zinc-plated finish for corrosion resistance and longevity.
- Supports both top and mid-rail guardrails, and toe boards when used in edge grab configuration.
- Use with standard wood 2×4's or other common guardrail materials.



Edge grab configuration



Parapet configuration

Accessories

7900008

Guardrail Roof Hatch Kit

Includes: (4 ea.) 7900060 Guardrail Bases, (1 ea.) 7900007 Guardrail Gate, (3 ea.) 7900005 Guardrail Splice Kits, (3 ea.) 7900061 6 ft. Rails.

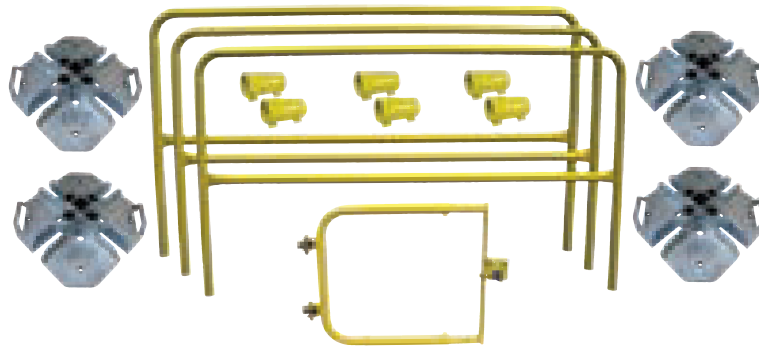

7900054

Guardrail Base Transport Cart

Accommodates 4 bases (not shown).



3M Science.
Applied to Life.™

3M Health & Safety eLearning

Training anywhere, anytime.

Do it your way with flexible and mobile eLearning.

Whether you work in the field or train those who do, you can enhance your health and safety knowledge at a pace that's right for you. Get 24/7 access to valuable health and safety education and training resources via 3M Academy. Registration is fast and easy, so you can get started right away.

Choose from our expanded offering of modules and topics covering respiratory protection, protective eyewear, hearing protection, fall protection and more.

- Workplace safety hazards and health risks
- OSHA PPE regulatory requirements
- Proper use and maintenance of 3M PPE
- Certificates and quizzes
- Progress tracking and monitoring

Get started today at [3M.com/WHSAcademy](https://www.3m.com/WHSAcademy).



Our site or yours. Training anytime, anywhere.

3M Fall Protection offers a full range of fall protection and industrial rescue courses at our training centers in Red Wing, MN, Houston, TX and Orange County, CA. We also offer on-site training in your workers' everyday environment at your facility. Contact us for more information.

Our comprehensive training provides practical, hands-on experience, including scaffolding, fixed ladders, towers, sloped roofs, rebar walls, elevated catwalks, I-beams and confined spaces.

Open enrollment courses

Designed to train workers to comply with regulatory requirements.

- Fall Protection Competent Person.
- Fall Protection Competent Person Trainer.
- Fall Protection Equipment Inspector.
- Fall Protection Program Administrator.
- Competent Climber and Rescuer.
- Fall Protection Authorized Person.
- Fall Protection Qualified Person.
- Fall Protection Competent Person Refresher.
- Wind Energy Fall Protection Competent Rescuer.
- Wind Energy Fall Protection Competent Rescuer Trainer.
- Confined Space Entry Supervisor/Entrant.
- Confined Space Entry Rescuer.
- Confined Space Entry Trainer.
- Fall Protection Competent Industrial Rescuer.
- Fall Protection Competent Tower Rescuer.
- Dropped Object Prevention Competent Person.
- Construction Silica Competent Person.

Safety on demand

3M provides 24/7 access to valuable health and safety education and training resources via 3M Academy. Equip yourself and your team with knowledge on a variety of subject matter, including workplace safety hazards and health risks, OSHA personal protective equipment regulatory requirements and proper use and maintenance of 3M personal protective equipment.

Industry-specific and custom courses

3M Fall Protection will create custom training courses tailored to your site and workers, with hands-on demonstrations to resolve fall protection hazards in and around your facility.

Fall protection awareness demonstrations

An excellent introduction to fall protection, one of our specialized vehicles can bring on-site fall protection demonstrations to your workers.

Your employees rely on you to get the most comprehensive safety training available. Find out how at [3M.com/FallProtection](https://www.3m.com/FallProtection).



3M Science.
Applied to Life.™

3M Fall Protection Training

Dropped Object Prevention Competent Person

Objects dropped from height can result in severe personal injuries on a jobsite, equipment damage and tool loss, yet these hazards are often overlooked when planning workplace safety.

This interactive course teaches how to implement the ABC's of Fall Protection for Tools. It's recommended for all individuals who work at height.

Topics include:

- Common dropped objects hazards
- ABC's of Fall Protection for Tools
- Passive dropped object protection systems
- Tool restraint and tool arrest systems

Learn more about Fall Protection for Tools and other training opportunities at [3M.com/FallProtection](https://www.3m.com/FallProtection).

Fall Protection for Tools



The science of fighting gravity.

Protecting workers takes more than just keeping them from falling. Tools, objects and equipment dropped from height can be just as hazardous. From construction sites to oil rigs, we help make work environments safer and more productive by protecting workers from hazards that can result in personal injury, equipment damage and tool loss.

There are a number of important steps that must be included in any comprehensive dropped object prevention program. They include: identification of drop hazards, design of corrective measures, implementation of those measures, an inspection or audit program, selection and use of proper equipment and/or systems, and in-depth training programs.

Everything you need to stop the drop.

Just like the ABC's of fall protection for workers, tools and objects require the proper anchorage, connector and attachment point (body support). The tool tether is only part of a complete Fall Protection for Tools 3-point system solution. You also need an attachment point and anchorage to ensure they're secure.

How to select a system:

There are many factors that go into choosing the system for any one worker's situation. This requires making specific determinations.

How heavy is the tool or equipment?

- Weight will help determine what kind of tether (connector), attachment point and anchorage should be used.
- Use a scale or check the manufacturer's specs to determine the weight of the tool.

A. What's the anchor point?

- The weight and use of the tool are critical factors in this decision.
- On the body vs. off the body (It's recommended that tools over 5 lbs. (2.3 kg) should never be anchored to the body).

B. What are the attachment point options?

- Depending on the tool, there may be more than one option.
- Some manufacturers may have attachment points engineered into the design of the tool.
- The correct attachment point should not impact tool use.

C. What's the appropriate connector for the tool?

- Usually there is more than one option—one size does not fit all.
- Connectors should not impact tool use.

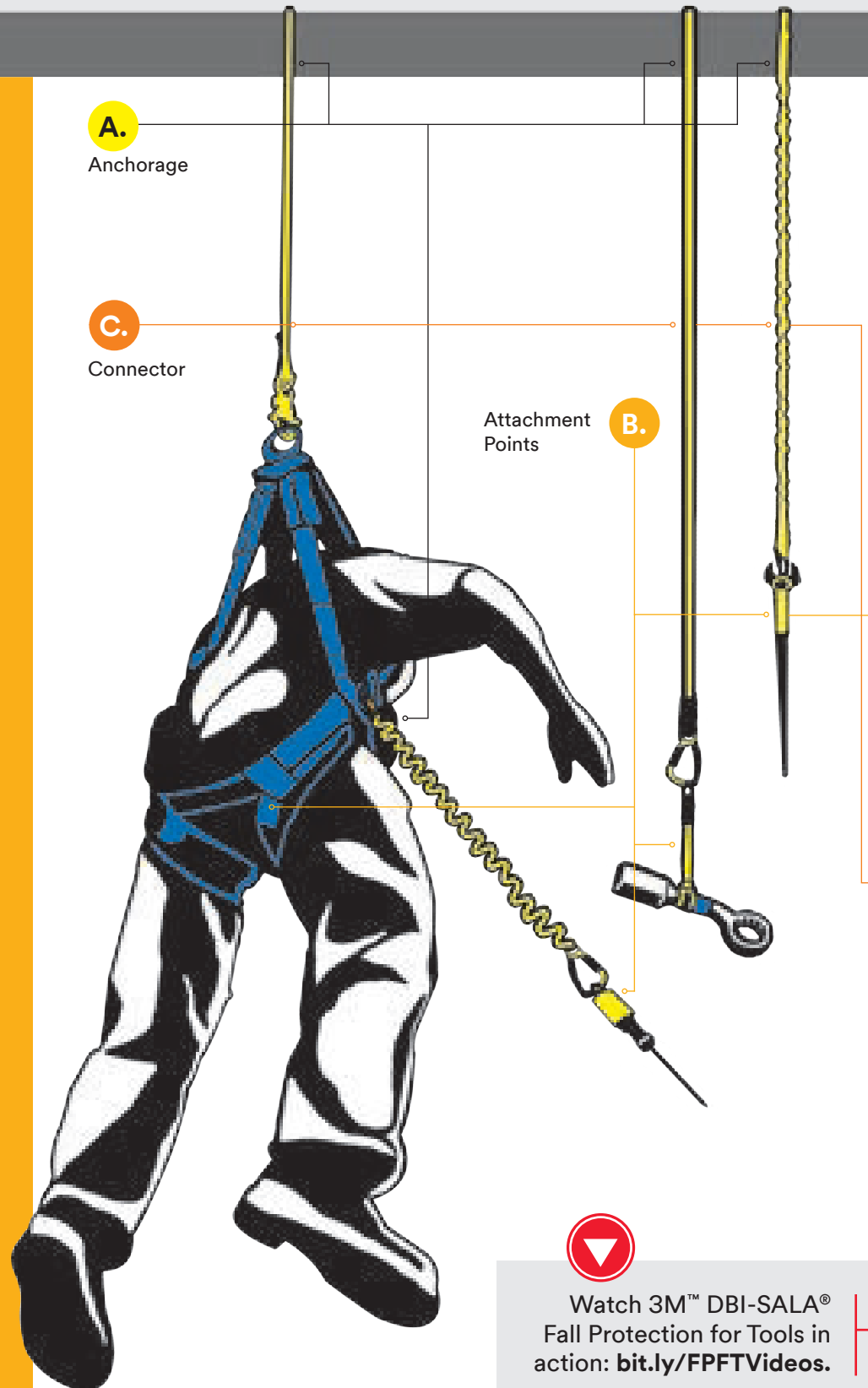

Watch 3M™ DBI-SALA®
Fall Protection for Tools in
action: bit.ly/FPFTVideos.

Every industry is different. Every jobsite is different. Every worker is different.

That's why 3M™ DBI-SALA® Fall Protection for Tools offers a vast portfolio of anchorage, connector and attachment point solutions for a wide variety of industries and occupations. From carpenters to concrete finishers and iron workers to welders, we have the solutions that can help you.

Here's a sampling of some of our most popular products.

B. Attachment Points



**1500174,
1500168,
1500171**
Quick-Wrap Tape II.
Load Rating: 2 lbs.
(0.9 kg)



1500010
Micro D-Ring.
Load Rating:
2 lbs. (only
when used with
1500060).



**1500027,
1500028,
1500029,
1500030**
Quick Spin. Sm-XL.
Load Rating: 1 lb.
(0.05 kg)



**1500024,
1500025,
1500026**
Quick Ring.
0.75-1.5 in.
Load Rating:
2 lbs. (0.9 kg)



1500003
D-Ring
0.5 in. x 2.25 in.
Load Rating:
2 lbs. (0.9 kg)



1500007
D-Ring 1 in.
x 3.5 in. Load
Rating: 5 lbs.
(2.7 kg)



1500009
D-Ring Cord.
Load Rating:
5 lbs. (2.7 kg)

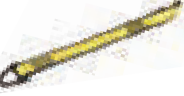

1500011
Tool Cinch MD.
Load Rating:
35 lbs. (15.9 kg)



1500013
Tool Cinch MD
Single Wing. Load
Rating: 35 lbs.
(15.9 kg)



1500015
Tool Cinch MD
Dual Wing.
Load Rating:
35 lbs. (15.9 kg)



1500017
Tool Cinch Heavy
Duty. Load Rating:
80 lbs. (36.3 kg)

C. Tool Tethers



1500156
5 lb. Retractable
Tool Lanyard
with 1500161
Harness
Adapter.



**1500159,
1500160**
Hook2Hook
Coil Tether
with Swivel.
Qty. 1 or 10.
Load Rating:
5 lbs. (2.3 kg)



**1500178,
1500179**
Hard Hat Tether.
Qty. 10 or 100.
Load Rating:
4 lbs. (1.8 kg)



1500047
Hook2Loop
Bungee Tether.
Load Rating:
15 lbs. (4.5 kg)



1500049
Medium-Duty
Hook2Loop
Bungee Tether.
Load Rating:
35 lbs. (15.9 kg)



1500050
Medium-Duty
Hook2Loop
Lanyard. Load
Rating: 35 lbs.
(15.9 kg)



1500051
Heavy-Duty Hook2Loop Lanyard.
Load Rating: 80 lbs. (36.3 kg)



1500052
Heavy-Duty Hook2Rail Lanyard.
Load Rating: 80 lbs. (36.3 kg)



View our full range of solutions: www.3m.com/droppedobjectsprevention

Contact 3M Fall Protection about our Dropped Object Competent Person training course.

Request a 3M™ DBI-SALA® Fall Protection for Tools catalog.

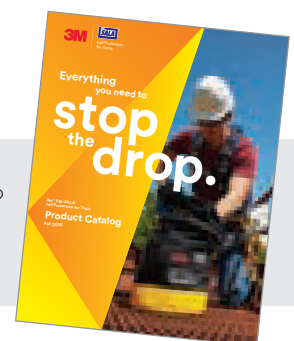

F

Fall Protection for Tools



3M Fall Protection

3833 SALA Way
Red Wing, MN 55066 USA

Phone 800.328.6146
Email 3mfallprotection@mmm.com
Web 3M.com/FallProtection

3M, DBI-SALA, Adjust-A-Net, Border Guard, Cynch-Lok, Delta, Delta Vest, ExoFit, ExoFit NEX, EZ-Stop, Flexiguard, Force, Lad-Saf, Nano-Lok, Rollgliss, RoofSafe, SafRig, Salalift, Sayflink, SecuraSpan, ShockWave, STRATA, Talon, Ultra-Lok and Zorbit are registered trademarks of 3M.

Kevlar, Nomex and Technora are trademarks of their respective owners.

© 3M 2018.
9700505 Rev E